

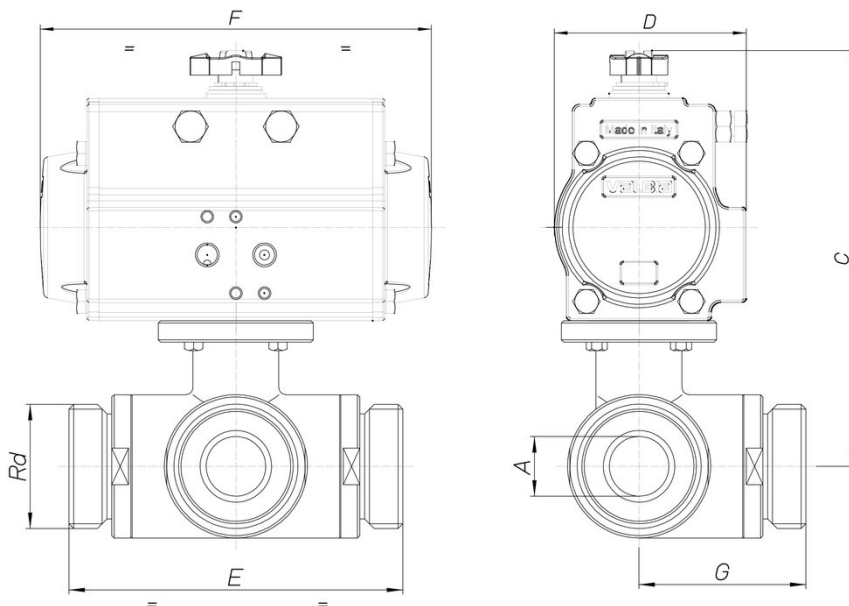

8P022000

3-Wege-Kugelhahn, aus Vollmaterial, "T" oder "L"
Bohrung, vierseitige Kugeldichtung, voller Durchgang,
Anschlüsse DIN 11851 I/I/I, aus Edelstahl AISI 316, mit
Antrieb.

Technische Spezifikationen



MOD	PN	A	RD	C	D	E	F	G	ACT.
8P02200003	40	10	28x1/8"	210	81	108	164	54	SR 63
8P02200004	40	15	34x1/8"	212	81	118	164	59	SR 63
8P02200005	40	20	44x1/6"	202	106	130	241	65	SR 85
8P02200006	40	25	52x1/6"	206	106	140	241	70	SR 85
8P02200007	40	32	58x1/6"	227	106	156	241	78	SR 85
8P02200008	40	40	65x1/6"	247	123	172	275	86	SR 100
8P02200010	25	50	78x1/6"	250	123	182	275	91	SR 100
8P02200012	25	65	95x1/6"	294	137	196	333	98	SR 115
8P02200014	16	80	110x1/4"	321	148	256	372	128	SR 125
8P02200018	16	100	130x1/4"	358	164	286	435	143	SR 140