

8P016800

3-Wege-Kugelhahn aus PVC, "T" oder "L" Bohrung, mit Klebmuffe metrisch, mit Antrieb.

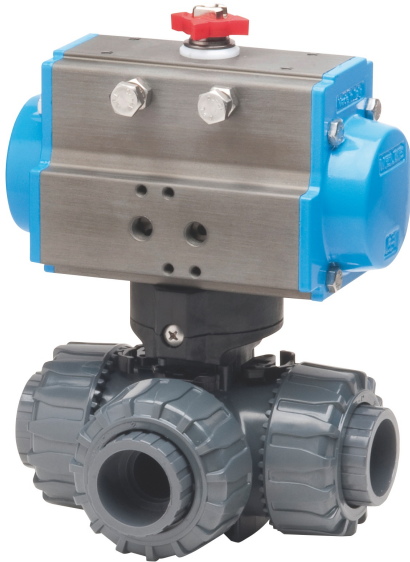

Technische Spezifikationen

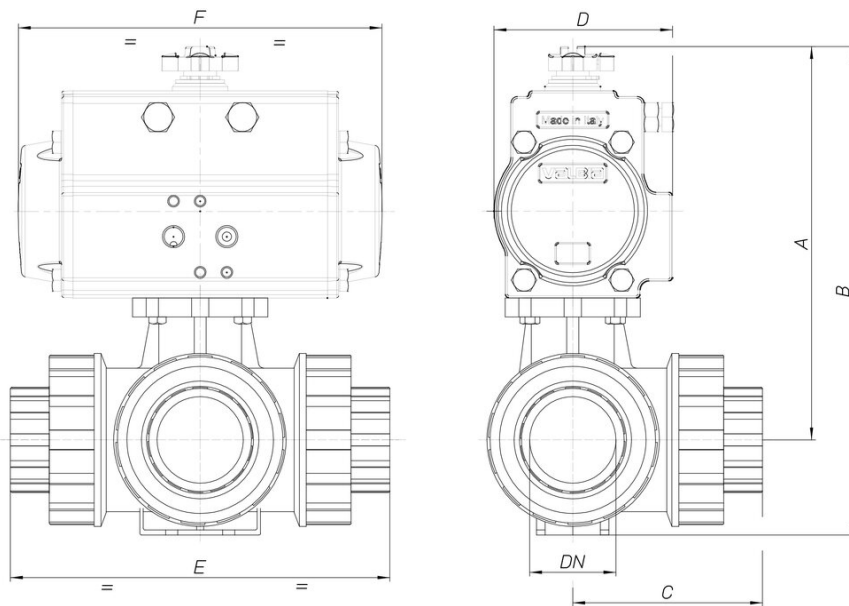

MOD	PN	A	B	C	D	E	F	ACT.
8P01680004	16	160	189	59	71	118	141	SR 52
8P01680005	16	182	217	73	81	145	164	SR 63
8P01680006	16	187	226	80	81	160	164	SR 63
8P01680007	16	222	268	95	95	189	210	SR 75
8P01680008	16	228	280	110	95	219	210	SR 75
8P01680010	16	259	321	106	106	267	241	SR 85

