

8P005600

3-Wege-Kugelhahn, (Ablenker), [Valpres Art. 776000 (L) - 776001 (T)], "T" oder "L" Bohrung, 2-seitig dichtend, Flansch PN16, aus Stahl ASTM A105, reduzierter Durchgang, mit Antrieb.

Technische Spezifikationen

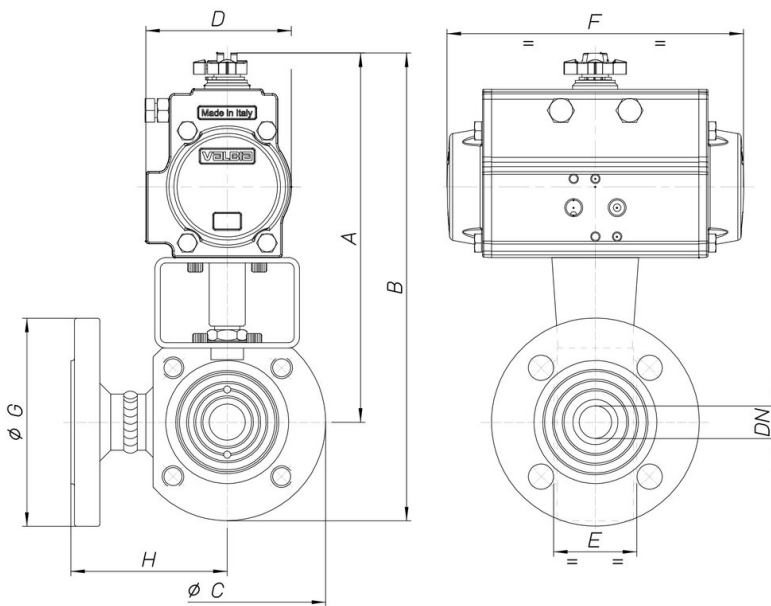

MOD	PN	A	B	Ø C	D	E	F	Ø G	H	ACT.	RI
8P00560004	16	183	228	89	71	40	141	95	76	SR 52	3780
8P00560005	16	199	249	99	81	40	164	105	82	SR 63	3014
8P00560006	16	204	259	109	81	46	164	115	86	SR 63	3007
8P00560007	16	212	277	130	81	58	164	140	105	SR 63	3048
8P00560008	16	259	329	140	106	71	241	150	110	SR 85	3009
8P00560010	16	278	358	160	123	82	275	165	120	SR 100	3009
8P00560012	16	349	439	180	137	106	333	185	125	SR 115	3010
8P00560014	16	370	470	200	148	122	372	200	150	SR 125	3010
8P00560018	16	387	497	220	148	152	372	220	159	SR 125	3005
8P00560019	16	409	534	250	148	196	372	250	190	SR 125	3036
8P00560020	16	449	602	306	164	242	435	285	210	SR 140	4562