

8P028900

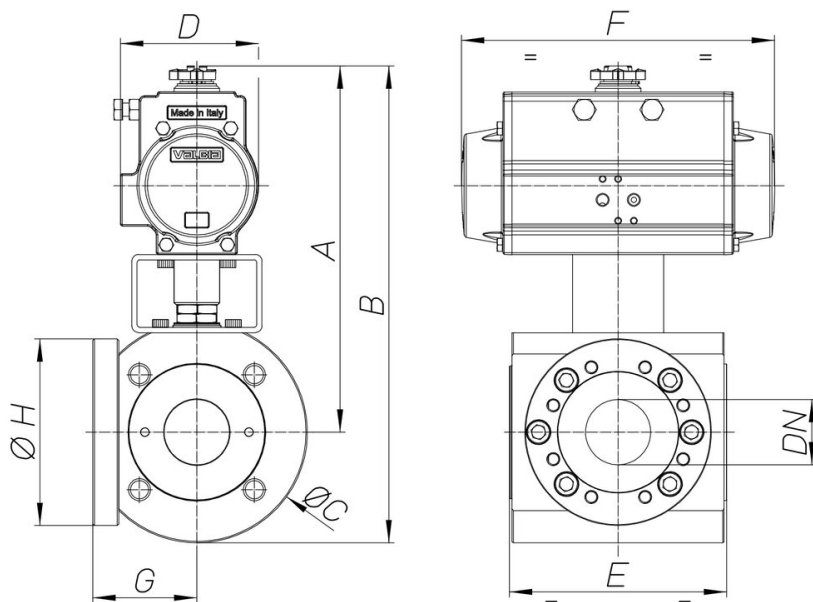

3 way ball valve [Valpres art. 776600 (T) - 776601 (L)],
 T or L port with 4 seats, PN16 flanged, carbon steel
 ASTM A105, full bore, Antistatic Device.

Technische Spezifikationen



MOD	PN	A	B	ØC	D	E	F	G	ØH	ACT.	RI
8P02890004	16	198	242	88	81	99	164	35	/	SR 63	4409
8P02890005	16	249	299	100	106	108	241	40	/	SR 85	4413
8P02890006	16	254	309	109	106	115	241	41,5	/	SR 85	4131
8P02890007	16	280	345	133	123	140	275	52,5	/	SR 100	4410
8P02890008	16	287	362	150	123	150	275	56,5	/	SR 100	4414
8P02890010	16	330	415	168	137	167	333	62	/	SR 115	3550
8P02890012	16	353	458	208	148	185	372	85	/	SR 125	4415
8P02890014	16	414	529	229	164	216	435	127	212	SR 140	4406
8P02890018	16	437	576	278	164	244	435	150	239	SR 140	4406