

8M259



2 way Wafer ball valve [Valpres art. 721V00 DN15 to DN100 (DN65 and DN100 only PN16) art.721V78 DN65 and DN100 only PN40] flanged PN16/40, stainless steel A351-CF8M, full bore, EN 558 basic series 100, metric thread, V-Pack stem seal, Fire Safe, Antistatic Device. With electric actuator series 85.

NEW

Technische Spezifikationen

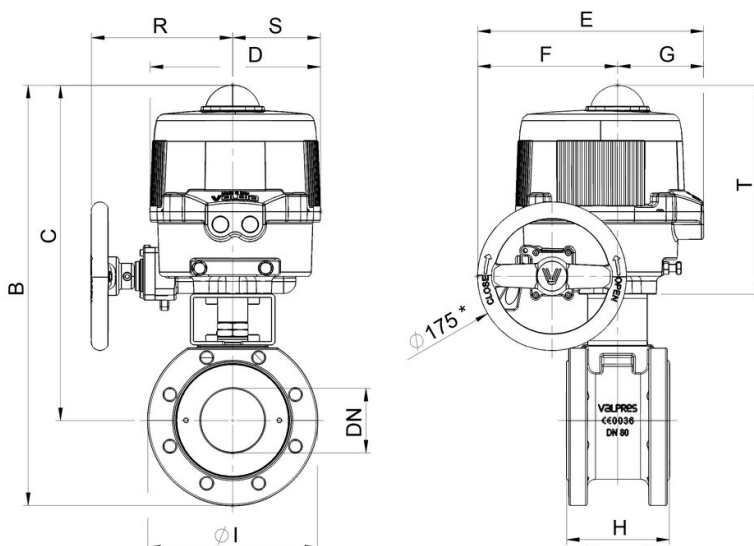

* mod.VB030M-VB060M Q10mm SENZA VOLANTINO - without handwheel

MOD	PN	B	C	D	E	F	G	H	I	R	S	T	ACT.	KIT
8M25900106	16-40	351	293	161	187	63	124	46	115	-	-	-	VB 030M	RI3542
8M25900206	16-40	351	293	161	187	63	124	46	115	-	-	-	VB 030M	RI3542
8M25900406	16-40	351	293	161	187	63	124	46	115	-	-	-	VB 030M	RI3542
8M25900107	16-40	369	299	161	187	63	124	54	140	-	-	-	VB 060M	RI3542
8M25900207	16-40	369	299	161	187	63	124	54	140	-	-	-	VB 060M	RI3542
8M25900407	16-40	369	299	161	187	63	124	54	140	-	-	-	VB 060M	RI3542
8M25900108	16-40	409	334	176	197	63	134	64	150	-	-	-	VB 060M	RI3521
8M25900208	16-40	409	334	176	197	63	134	64	150	-	-	-	VB 060M	RI3521
8M25900408	16-40	409	334	176	197	63	134	64	150	-	-	-	VB 060M	RI3521
8M25900110	16-40	425	342	176	197	63	134	82	165	-	-	-	VB 060M	RI3521
8M25900210	16-40	425	342	176	197	63	134	82	165	-	-	-	VB 060M	RI3521
8M25900410	16-40	425	342	176	197	63	134	82	165	-	-	-	VB 060M	RI3521
8M25900112	16	478	386	200	266	165	101	103	185	167	103	225	VB 110M	RI3522
8M25900212	16	478	386	200	266	165	101	103	185	167	103	225	VB 110M	RI3522
8M25900412	16	478	386	200	266	165	101	103	185	167	103	225	VB 110M	RI3522
8M25900114	40	478	386	200	266	165	101	103	185	167	103	225	VB 110M	RI5345
8M25900214	40	478	386	200	266	165	101	103	185	167	103	225	VB 110M	RI5345
8M25900414	40	478	386	200	266	165	101	103	185	167	103	225	VB 110M	RI5345
8M25900118	16-40	493	393	200	266	165	101	122	200	167	103	225	VB 190M	RI3552
8M25900218	16-40	493	393	200	266	165	101	122	200	167	103	225	VB 190M	RI3552
8M25900418	16-40	493	393	200	266	165	101	122	200	167	103	225	VB 190M	RI3552