

8M164

3 way ball valve [Valpres artt. 776600 (T) - 776601 (L)],
 T or L port with 4 seats, PN16 flanged, carbon steel
 ASTM A105, full bore, Antistatic Device.

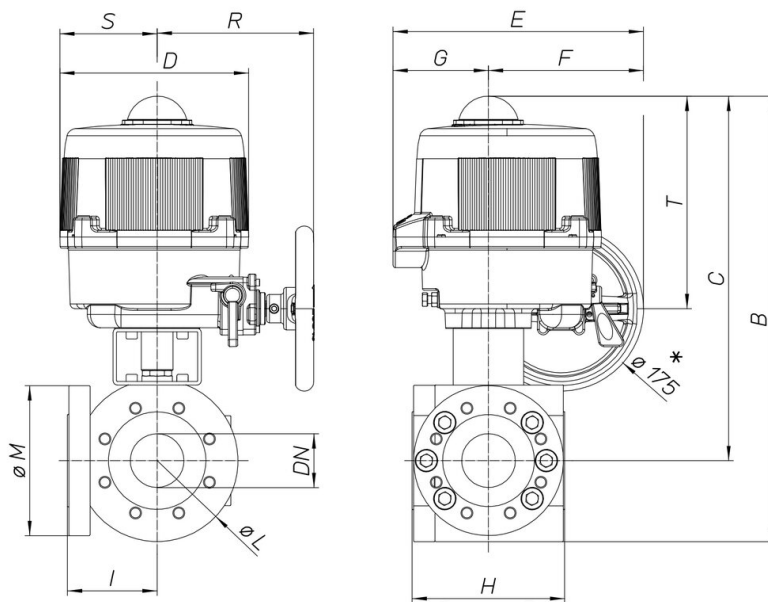

Technische Spezifikationen



MOD	PN	B	C	D	E	F	G	H	I	ØL	ØM	R	S	T	ACT.	RI
8M16400105	16	343	293	161	187	63	124	108	40	100	-	-	-	-	VB 030M	3520
8M16400205	16	343	293	161	187	63	124	108	40	100	-	-	-	-	VB 030M	3520
8M16400405	16	343	293	161	187	63	124	108	40	100	-	-	-	-	VB 030M	3520
8M16400106	16	363	308	161	187	63	124	115	42	109	-	-	-	-	VB 030M	3520
8M16400206	16	363	308	161	187	63	124	115	42	109	-	-	-	-	VB 030M	3520
8M16400406	16	363	308	161	187	63	124	115	42	109	-	-	-	-	VB 030M	3520
8M16400107	16	407	342	176	197	63	134	140	53	133	-	-	-	-	VB 060M	4416
8M16400207	16	407	342	176	197	63	134	140	53	133	-	-	-	-	VB 060M	4416
8M16400407	16	407	342	176	197	63	134	140	53	133	-	-	-	-	VB 060M	4416
8M16400108	16	424	349	176	197	63	134	150	57	150	-	-	-	-	VB 060M	4039
8M16400208	16	424	349	176	197	63	134	150	57	150	-	-	-	-	VB 060M	4039
8M16400408	16	424	349	176	197	63	134	150	57	150	-	-	-	-	VB 060M	4039
8M16400110	16	468	383	200	266	165	101	167	62	168	-	167	103	225	VB 110M	3522
8M16400210	16	468	383	200	266	165	101	167	62	168	-	167	103	225	VB 110M	3522
8M16400410	16	468	383	200	266	165	101	167	62	168	-	167	103	225	VB 110M	3522
8M16400112	16	499	394	200	266	165	101	185	85	208	-	167	103	225	VB 190M	4411
8M16400212	16	499	394	200	266	165	101	185	85	208	-	167	103	225	VB 190M	4411
8M16400412	16	499	394	200	266	165	101	185	85	208	-	167	103	225	VB 190M	4411
8M16400114	16	550	435	212	279	184	95	216	127	229	212	166	109	226	VB 270M	4412
8M16400214	16	550	435	212	279	184	95	216	127	229	212	166	109	226	VB 270M	4412
8M16400414	16	550	435	212	279	184	95	216	127	229	212	166	109	226	VB 270M	4412
8M16400118	16	570	431	212	279	184	95	244	150	278	239	166	109	226	VB 270M	4412
8M16400218	16	570	431	212	279	184	95	244	150	278	239	166	109	226	VB 270M	4412
8M16400418	16	570	431	212	279	184	95	244	150	278	239	166	109	226	VB 270M	4412