

## 8E026

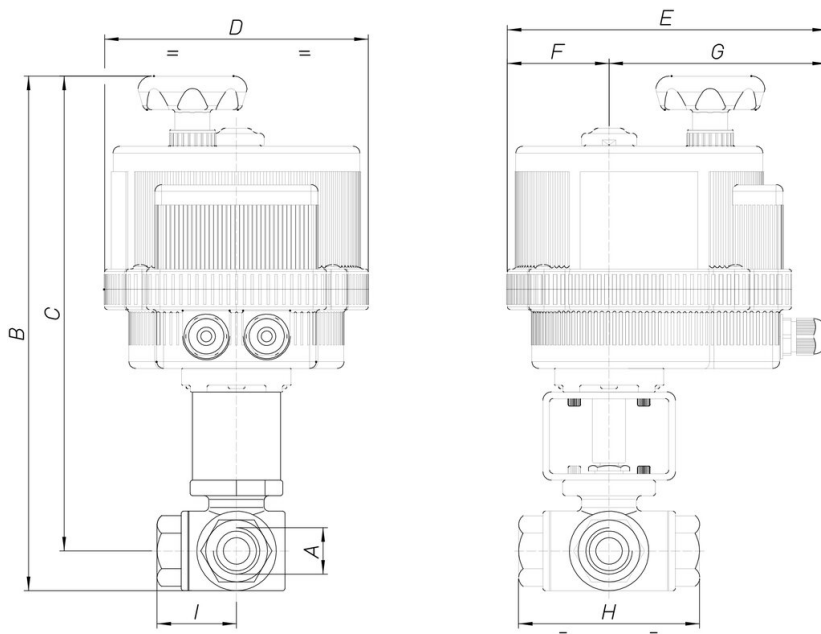

3 way ball valve [Valpres art. 772000 (T) - 775000 (L)] investment casted, stainless steel AISI 316-CF8M, threaded F/F/F with 4 seats, reduced bore, "T" or "L" port, with electric actuator series 85.

### Technische Spezifikationen



MOD	PN	A	B	C	D	E	F	G	H	I	ACT.	RI
8E02600102	63	1/4"	235	219	123	164	43	121	70	35	VB 015	3760
8E02600202	63	1/4"	235	219	123	164	43	121	70	35	VB 015	3760
8E02600402	63	1/4"	235	219	123	164	43	121	70	35	VB 015	3760
8E02600103	63	3/8"	235	219	123	164	43	121	70	35	VB 015	3760
8E02600203	63	3/8"	235	219	123	164	43	121	70	35	VB 015	3760
8E02600403	63	3/8"	235	219	123	164	43	121	70	35	VB 015	3760
8E02600104	63	1/2"	239	223	123	164	43	121	76	38	VB 015	3760
8E02600204	63	1/2"	239	223	123	164	43	121	76	38	VB 015	3760
8E02600404	63	1/2"	239	223	123	164	43	121	76	38	VB 015	3760
8E02600105	63	3/4"	306	285	157	191	61	130	87	45	VB 030	3761
8E02600205	63	3/4"	306	285	157	191	61	130	87	45	VB 030	3761
8E02600405	63	3/4"	306	285	157	191	61	130	87	45	VB 030	3761
8E02600106	63	1"	314	289	157	191	61	130	103	52	VB 030	4034
8E02600206	63	1"	314	289	157	191	61	130	103	52	VB 030	4034
8E02600406	63	1"	314	289	157	191	61	130	103	52	VB 030	4034
8E02600107	63	1"1/4	322	295	157	191	61	130	118	58	VB 030	4035
8E02600207	63	1"1/4	322	295	157	191	61	130	118	58	VB 030	4035
8E02600407	63	1"1/4	322	295	157	191	61	130	118	58	VB 030	4035
8E02600108	63	1"1/2	381	347	211	237	84	153	126	63	VB 110	3764
8E02600208	63	1"1/2	381	347	211	237	84	153	126	63	VB 110	3764
8E02600408	63	1"1/2	381	347	211	237	84	153	126	63	VB 110	3764
8E02600110	63	2"	396	356	211	237	84	153	149	75	VB 110	3003
8E02600210	63	2"	396	356	211	237	84	153	149	75	VB 110	3003
8E02600410	63	2"	396	356	211	237	84	153	149	75	VB 110	3003