

8E019

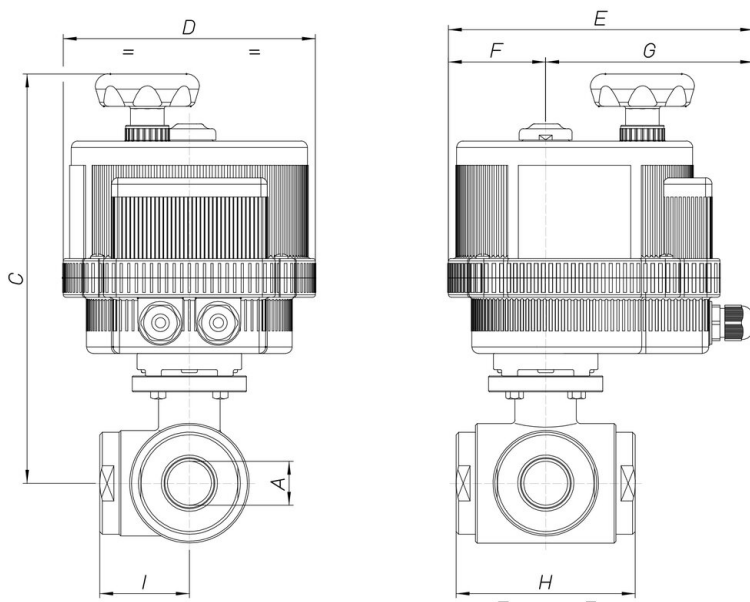

3-Wege Kugelhahn, aus Edelstahl AISI 316 Vollmaterial, "T" oder "L" Bohrung, vierseitige Kugeldichtung, voller Durchgang, Anschlüsse Innengewinde ISO 228, mit elektrischem Antrieb.

Technische Spezifikationen



MOD	PN	A	C	D	E	F	G	H	I	ACT.
8E01900102	40	1/4"	189	123	164	43	121	72	36	VB 015
8E01900202	40	1/4"	189	123	164	43	121	72	36	VB 015
8E01900402	40	1/4"	189	123	164	43	121	72	36	VB 015
8E01900103	40	3/8"	189	123	164	43	121	72	36	VB 015
8E01900203	40	3/8"	189	123	164	43	121	72	36	VB 015
8E01900403	40	3/8"	189	123	164	43	121	72	36	VB 015
8E01900104	40	1/2"	191	123	164	43	121	82	41	VB 015
8E01900204	40	1/2"	191	123	164	43	121	82	41	VB 015
8E01900404	40	1/2"	191	123	164	43	121	82	41	VB 015
8E01900105	40	3/4"	245	157	191	61	130	92	46	VB 030 *
8E01900205	40	3/4"	245	157	191	61	130	92	46	VB 030 *
8E01900405	40	3/4"	245	157	191	61	130	92	46	VB 030 *
8E01900106	40	1"	249	157	191	61	130	102	51	VB 030*
8E01900206	40	1"	249	157	191	61	130	102	51	VB 030*
8E01900406	40	1"	249	157	191	61	130	102	51	VB 030*
8E01900107	40	1"1/4	297	185	215	68	147	118	59	VB 060
8E01900207	40	1"1/4	297	185	215	68	147	118	59	VB 060
8E01900407	40	1"1/4	297	185	215	68	147	118	59	VB 060
8E01900108	40	1"1/2	304	185	215	68	147	134	67	VB 060 *
8E01900208	40	1"1/2	304	185	215	68	147	134	67	VB 060 *
8E01900408	40	1"1/2	304	185	215	68	147	134	67	VB 060 *
8E01900110	25	2"	307	185	215	68	147	144	72	VB 060 *
8E01900210	25	2"	307	185	215	68	147	144	72	VB 060 *
8E01900410	25	2"	307	185	215	68	147	144	72	VB 060 *
8E01900112	25	2"1/2	334	211	237	84	153	160	80	VB 110
8E01900212	25	2"1/2	334	211	237	84	153	160	80	VB 110
8E01900412	25	2"1/2	334	211	237	84	153	160	80	VB 110
8E01900114	16	3"	348	211	237	84	153	200	100	VB 190
8E01900214	16	3"	348	211	237	84	153	200	100	VB 190
8E01900414	16	3"	348	211	237	84	153	200	100	VB 190
8E01900118	16	4"	365	222	247	77	170	240	120	VB 350
8E01900218	16	4"	365	222	247	77	170	240	120	VB 350
8E01900418	16	4"	365	222	247	77	170	240	120	VB 350