

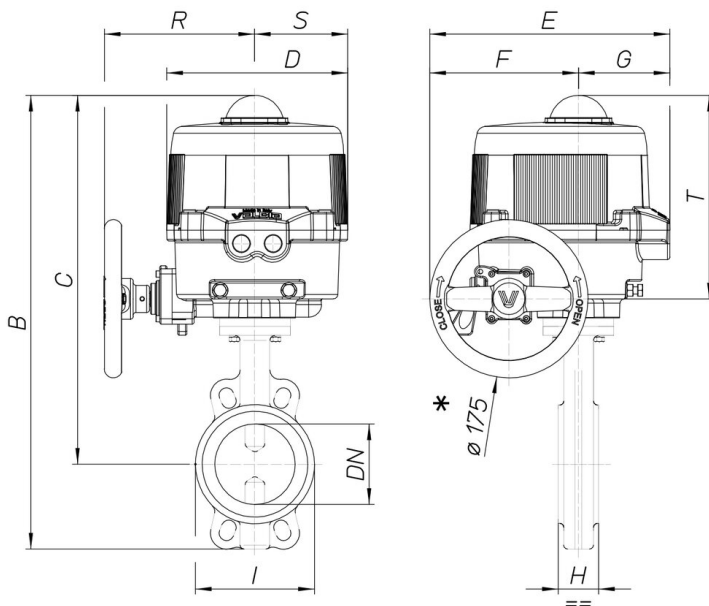

8M036

Butterfly valve Wafer type PN16, (from DN32 to DN300)
PN10 (from DN350 to DN600) body in cast iron
GG25+epoxy painting, disc AISI 316, EPDM [Valpres
art. 600105] or NBR [Valpres art. 600119] seat from
DN32 to DN300, EPDM seat art. 905257 from DN350 to
DN600.

Technische Spezifikationen



MOD	PN	B	C	D	E	F	G	H	I	R	S	T	ACT.	KIT
8M03600110	16	424	352	161	187	63	124	43	100	-	-	-	VB030M	RI3836
8M03600210	16	424	352	161	187	63	124	43	100	-	-	-	VB030M	RI3836
8M03600410	16	424	352	161	187	63	124	43	100	-	-	-	VB030M	RI3836
8M03600112	16	443	365	161	187	63	124	46	120	-	-	-	VB030M	RI3836
8M03600212	16	443	365	161	187	63	124	46	120	-	-	-	VB030M	RI3836
8M03600412	16	443	365	161	187	63	124	46	120	-	-	-	VB030M	RI3836
8M03600114	16	477	387	176	197	63	134	46	127	-	-	-	VB060M	RI3883
8M03600214	16	477	387	176	197	63	134	46	127	-	-	-	VB060M	RI3883
8M03600414	16	477	387	176	197	63	134	46	127	-	-	-	VB060M	RI3883
8M03600118	16	505	403	176	197	63	134	52	161	-	-	-	VB060M	RI3884
8M03600218	16	505	403	176	197	63	134	52	161	-	-	-	VB060M	RI3884
8M03600418	16	505	403	176	197	63	134	52	161	-	-	-	VB060M	RI3884
8M03600119	16	565	442	200	266	165	101	56	190	167	103	225	VB110M	RI3840
8M03600219	16	565	442	200	266	165	101	56	190	167	103	225	VB110M	RI3840
8M03600419	16	565	442	200	266	165	101	56	190	167	103	225	VB110M	RI3840
8M03600120	16	593	455	200	266	165	101	56	215	167	103	225	VB190M	RI3847
8M03600220	16	593	455	200	266	165	101	56	215	167	103	225	VB190M	RI3847
8M03600420	16	593	455	200	266	165	101	56	215	167	103	225	VB190M	RI3847
8M03600121	16	685	490	212	279	184	95	60	268	166	109	226	VB270M	RI3965
8M03600221	16	685	490	212	279	184	95	60	268	166	109	226	VB270M	RI3965
8M03600421	16	685	490	212	279	184	95	60	268	166	109	226	VB270M	RI3965
8M03600177	16	733	526	212	279	184	95	68	325	166	109	226	VB350M	RI3865
8M03600277	16	733	526	212	279	184	95	68	325	166	109	226	VB350M	RI3865
8M03600477	16	733	526	212	279	184	95	68	325	166	109	226	VB350M	RI3865