

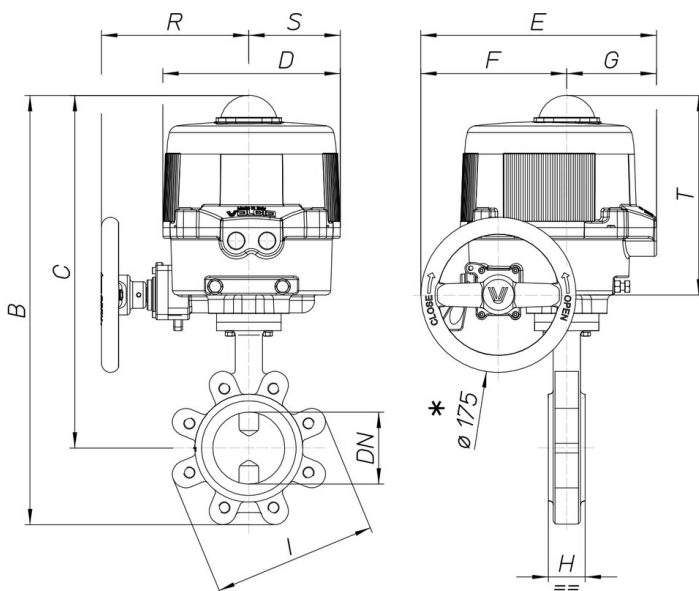

8M103

Butterfly valve Lug type PN16 (from DN50 to DN300), PN10 (from DN350 to DN600), body in cast iron GGG40 +epoxy painting, disc GGG40 nickeled, EPDM [Valpres art. 600204] or NBR [Valpres art. 600231] from DN50 to DN300 EPDM seat art. 905277 from DN350 to DN600.

Technische Spezifikationen



MOD	PN	B	C	D	E	F	G	H	I	R	S	T	ACT.	KIT
8M10300110	16	424	352	161	187	63	124	43	165	-	-	-	VB030M	RI3836
8M10300210	16	424	352	161	187	63	124	43	165	-	-	-	VB030M	RI3836
8M10300410	16	424	352	161	187	63	124	43	165	-	-	-	VB030M	RI3836
8M10300112	16	443	365	161	187	63	124	46	185	-	-	-	VB030M	RI3836
8M10300212	16	443	365	161	187	63	124	46	185	-	-	-	VB030M	RI3836
8M10300412	16	443	365	161	187	63	124	46	185	-	-	-	VB030M	RI3836
8M10300114	16	477	387	176	197	63	134	46	200	-	-	-	VB060M	RI3883
8M10300214	16	477	387	176	197	63	134	46	200	-	-	-	VB060M	RI3883
8M10300414	16	477	387	176	197	63	134	46	200	-	-	-	VB060M	RI3883
8M10300118	16	505	403	176	197	63	134	52	220	-	-	-	VB060M	RI3884
8M10300218	16	505	403	176	197	63	134	52	220	-	-	-	VB060M	RI3884
8M10300418	16	505	403	176	197	63	134	52	220	-	-	-	VB060M	RI3884
8M10300119	16	565	442	200	266	165	101	56	250	167	103	225	VB110M	RI3840
8M10300219	16	565	442	200	266	165	101	56	250	167	103	225	VB110M	RI3840
8M10300419	16	565	442	200	266	165	101	56	250	167	103	225	VB110M	RI3840
8M10300120	16	593	455	200	266	165	101	56	285	167	103	225	VB190M	RI3847
8M10300220	16	593	455	200	266	165	101	56	285	167	103	225	VB190M	RI3847
8M10300420	16	593	455	200	266	165	101	56	285	167	103	225	VB190M	RI3847
8M10300121	16	658	490	212	279	184	95	60	340	166	109	226	VB270M	RI3965
8M10300221	16	658	490	212	279	184	95	60	340	166	109	226	VB270M	RI3965
8M10300421	16	658	490	212	279	184	95	60	340	166	109	226	VB270M	RI3965
8M10300177	16	733	526	212	279	184	95	68	405	166	109	226	VB350M	RI3865
8M10300277	16	733	526	212	279	184	95	68	405	166	109	226	VB350M	RI3865
8M10300477	16	733	526	212	279	184	95	68	405	166	109	226	VB350M	RI3865