

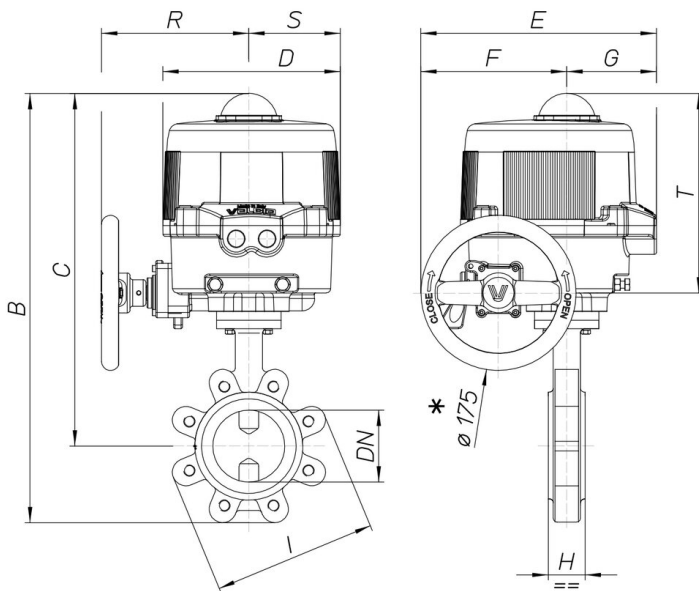

8M102

Butterfly valve Lug type PN16, (from DN40 to DN300)
 PN10 (from DN350 to DN600) body in cast iron
 GGG40+epoxy painting, disc AISI 316, EPDM [Valpres
 art. 600205] or NBR [Valpres art. 600230] seat from
 DN40 to DN300, EPDM seat art. 905262 from DN350 to
 DN600.

Technische Spezifikationen



MOD	PN	B	C	D	E	F	G	H	I	R	S	T	ACT.	KIT
8M10200110	16	424	352	161	187	63	124	43	165	-	-	-	VB030M	RI3836
8M10200210	16	424	352	161	187	63	124	43	165	-	-	-	VB030M	RI3836
8M10200410	16	424	352	161	187	63	124	43	165	-	-	-	VB030M	RI3836
8M10200112	16	443	365	161	187	63	124	46	185	-	-	-	VB030M	RI3836
8M10200212	16	443	365	161	187	63	124	46	185	-	-	-	VB030M	RI3836
8M10200412	16	443	365	161	187	63	124	46	185	-	-	-	VB030M	RI3836
8M10200114	16	477	387	176	197	63	134	46	200	-	-	-	VB060M	RI3883
8M10200214	16	477	387	176	197	63	134	46	200	-	-	-	VB060M	RI3883
8M10200414	16	477	387	176	197	63	134	46	200	-	-	-	VB060M	RI3883
8M10200118	16	505	403	176	197	63	134	52	220	-	-	-	VB060M	RI3884
8M10200218	16	505	403	176	197	63	134	52	220	-	-	-	VB060M	RI3884
8M10200418	16	505	403	176	197	63	134	52	220	-	-	-	VB060M	RI3884
8M10200119	16	565	442	200	266	165	101	56	250	167	103	225	VB110M	RI3840
8M10200219	16	565	442	200	266	165	101	56	250	167	103	225	VB110M	RI3840
8M10200419	16	565	442	200	266	165	101	56	250	167	103	225	VB110M	RI3840
8M10200120	16	593	455	200	266	165	101	56	285	167	103	225	VB190M	RI3847
8M10200220	16	593	455	200	266	165	101	56	285	167	103	225	VB190M	RI3847
8M10200420	16	593	455	200	266	165	101	56	285	167	103	225	VB190M	RI3847
8M10200121	16	658	490	212	279	184	95	60	340	166	109	226	VB270M	RI3965
8M10200221	16	658	490	212	279	184	95	60	340	166	109	226	VB270M	RI3965
8M10200421	16	658	490	212	279	184	95	60	340	166	109	226	VB270M	RI3965
8M10200177	16	733	526	212	279	184	95	68	405	166	109	226	VB350M	RI3865
8M10200277	16	733	526	212	279	184	95	68	405	166	109	226	VB350M	RI3865
8M10200477	16	733	526	212	279	184	95	68	405	166	109	226	VB350M	RI3865