



8E262

2 way Wafer ball valve [Valpres art.722V00 DN15 to DN100 (DN65 and DN100 only PN16) art.722V08 DN65 and DN100 only PN40] flanged PN16/40, carbon steel A105, full bore, EN 558 basic series 100, metric thread, V-Pack stem seal, Fire Safe, Antistatic Device. With electric actuator series 85.

NEW

Technische Spezifikationen

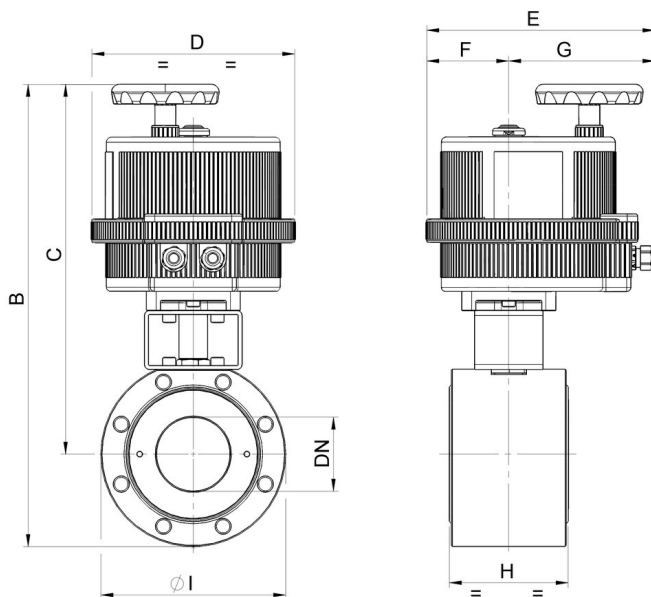

MOD	PN	B	C	D	E	F	G	H	I	ACT.	RI
8E26200104	16	269	224	123	164	43	121	35	90	VB 015	3780
8E26200204	16	269	224	123	164	43	121	35	90	VB 015	3780
8E26200404	16	269	224	123	164	43	121	35	90	VB 015	3780
8E26200105	16	278	228	123	164	43	121	40	100	VB 015	3013
8E26200205	16	278	228	123	164	43	121	40	100	VB 015	3013
8E26200405	16	278	228	123	164	43	121	40	100	VB 015	3013
8E26200106	16	335	280	157	191	61	130	46	110	VB 030	3001
8E26200206	16	335	280	157	191	61	130	46	110	VB 030	3001
8E26200406	16	335	280	157	191	61	130	46	110	VB 030	3001
8E26200107	16	351	286	157	191	61	130	54	130	VB 030	3008
8E26200207	16	351	286	157	191	61	130	54	130	VB 030	3008
8E26200407	16	351	286	157	191	61	130	54	130	VB 030	3008
8E26200108	16	399	329	185	215	68	147	64	140	VB 060	3002
8E26200208	16	399	329	185	215	68	147	64	140	VB 060	3002
8E26200408	16	399	329	185	215	68	147	64	140	VB 060	3002
8E26200110	16	412	337	185	215	68	147	82	150	VB 060	3002
8E26200210	16	412	337	185	215	68	147	82	150	VB 060	3002
8E26200410	16	412	337	185	215	68	147	82	150	VB 060	3002
8E26200112	16	456	369	211	237	84	153	103	175	VB 110	3003
8E26200212	16	456	369	211	237	84	153	103	175	VB 110	3003
8E26200412	16	456	369	211	237	84	153	103	175	VB 110	3003
8E26200114	16	474	379	211	237	84	153	122	190	VB 110	3003
8E26200214	16	474	379	211	237	84	153	122	190	VB 110	3003
8E26200414	16	474	379	211	237	84	153	122	190	VB 110	3003
8E26200118	16	525	415	211	237	84	153	152	220	VB 190	3004
8E26200218	16	525	415	211	237	84	153	152	220	VB 190	3004
8E26200418	16	525	415	211	237	84	153	152	220	VB 190	3004
8E26200119	16	562	437	211	237	84	153	196	250	VB 190	3004
8E26200219	16	562	437	211	237	84	153	196	250	VB 190	3004
8E26200419	16	562	437	211	237	84	153	196	250	VB 190	3004
8E26200120	16	614	464	222	247	77	170	232	300	VB 350	3006
8E26200220	16	614	464	222	247	77	170	232	300	VB 350	3006
8E26200420	16	614	464	222	247	77	170	232	300	VB 350	3006