

## MOD. VB190

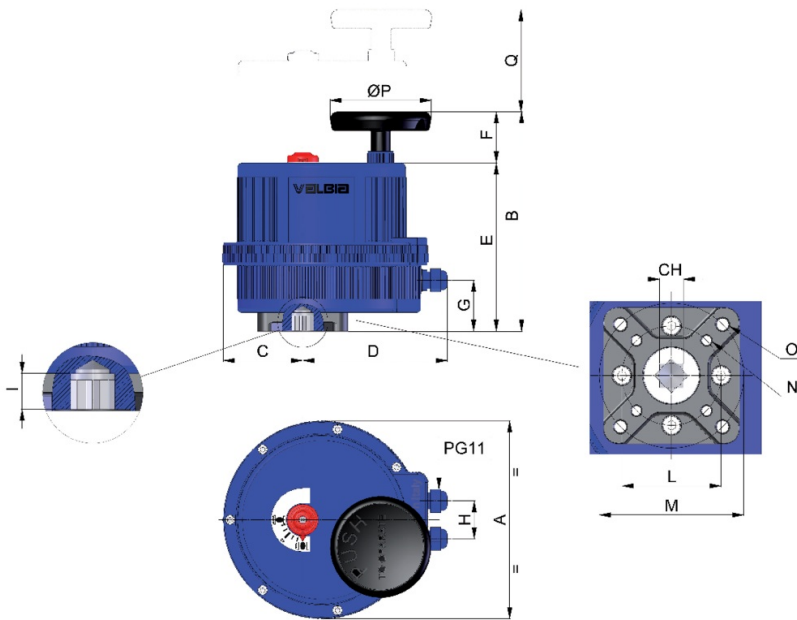

### Technical specifications



MOD	FORATURA DRILLING ISO 5211	CH	A	B	C	D	E	F	G	H	I	L	M	N	O	ØP	Q
MOD. VB190	F07-F10	17	211	232,1	84	153	178	54,1	54	40	19	70	102	M8x20	M10x20	110	115

# Applications



FOOD &  
BEVERAGE



HVAC



PAINTS &  
SOLVENTS



WATER  
TREATMENT



CHEMICAL



OEM



POWER &  
RENEWABLE  
ENERGY