

8P016700

3 way PVC ball valve, "T" or "L" port, with metric series plain female ends for solvent welding, with actuator.

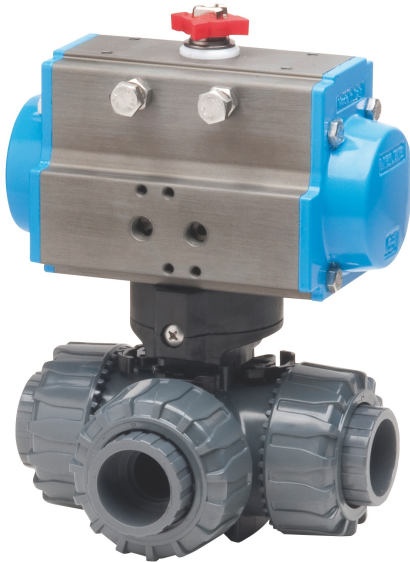

Technical specifications

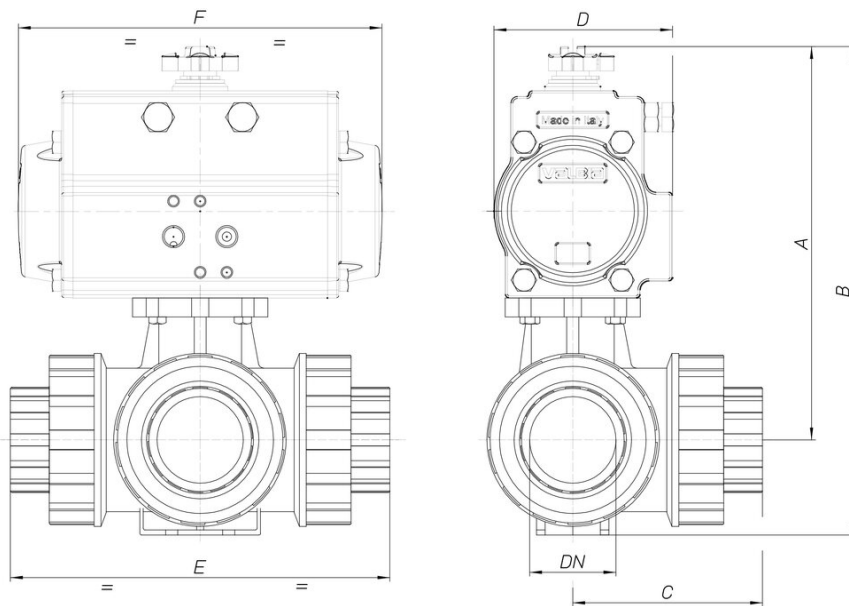

MOD	PN	A	B	C	D	E	F	ACT.
8P01670004	16	160	189	59	71	118	141	DA 52
8P01670005	16	182	217	73	81	145	164	DA 63
8P01670006	16	187	226	80	81	160	164	DA 63
8P01670007	16	204	250	95	81	189	164	DA 63
8P01670008	16	210	262	110	81	219	164	DA63
8P01670010	16	227	289	134	81	267	164	DA 63

