

8P015400

3 ways ball valve, 9SMnPb36, L or T port, diverting only, F/F/F threaded, for high pressure, with actuator. For Hydraulic oil, emulsion, gas. For particular applications, refer to Valbia.

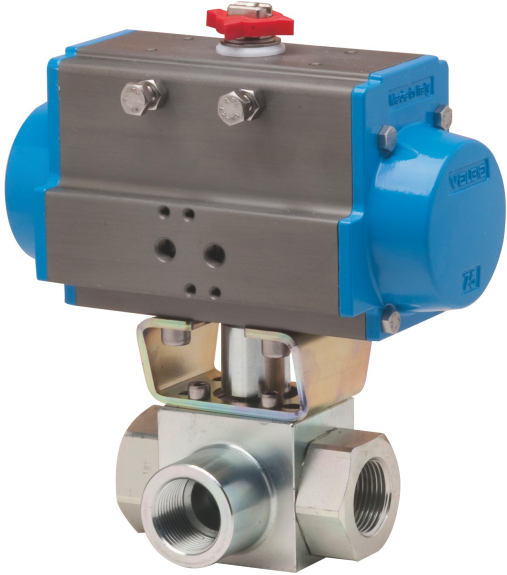

Technical specifications

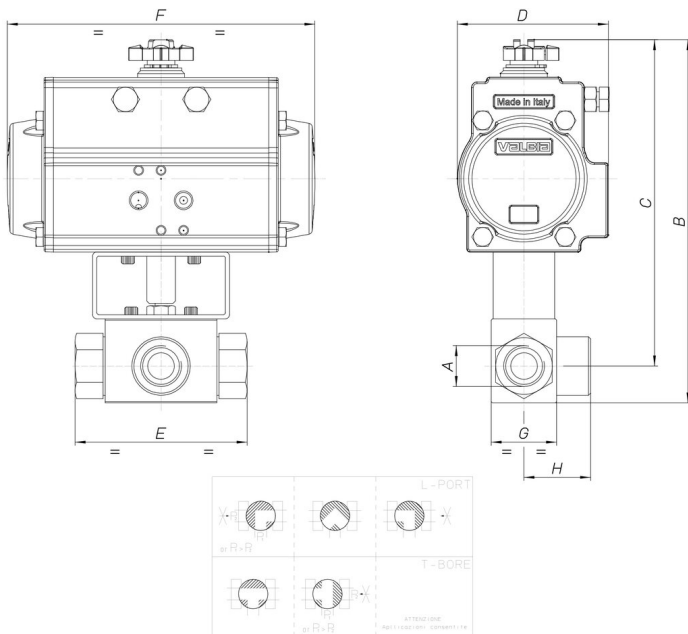

MOD	PN	A	B	C	D	E	F	G	H	ACT.	RI
8P01540003	400	3/8"	182	164	71	73	141	35	37	DA 52	3740
8P01540004	350	1/2"	196	178	81	83	164	37	40	DA 63	3741
8P01540005	350	3/4"	226	203	95	95	210	45	52	DA 75	3742
8P01540006	350	1"	236	207	95	112	210	55	60	DA 75	3742

