

## 8P023400

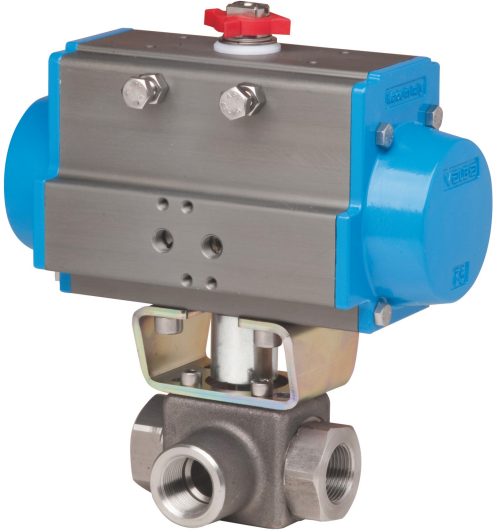

3 ways ball valve, AISI 316L, L or T port, diverting only, F/F/F threaded, for high pressure, with actuator. For Hydraulic oil, emulsion, gas. For particular applications, refer to Valbia.

### Technical specifications

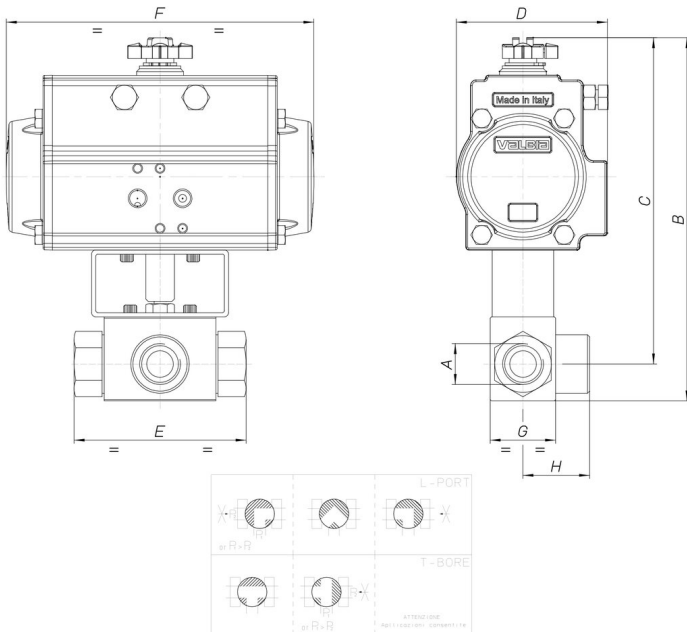

MOD	PN	A	B	C	D	E	F	G	H	ACT.	RI
8P02340003	400	3/8"	182	164	71	73	141	35	37	DA 52	3740
8P02340004	350	1/2"	196	178	81	83	164	37	40	DA 63	3741
8P02340005	350	3/4"	226	203	95	95	210	45	52	DA 75	3742
8P02340006	350	1"	236	207	95	112	210	55	60	DA 75	3742

