

## 8P023600

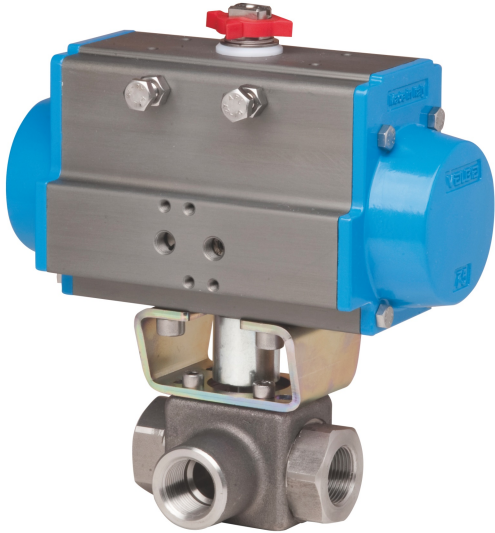

3 ways ball valve, AISI 316L, L or T port, diverting only, F/F/F threaded, for high pressure, with actuator. For Hydraulic oil, emulsion, gas. For particular applications, refer to Valbia.

### Technical specifications

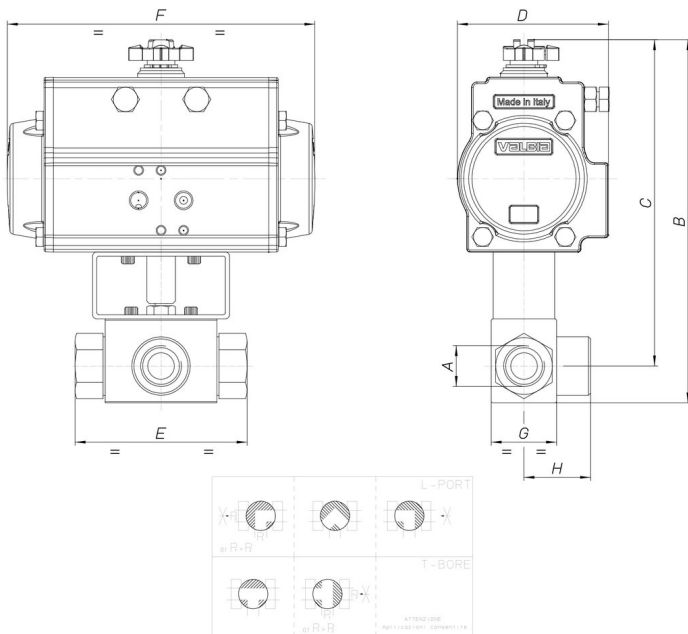

MOD	PN	A	B	C	D	E	F	G	H	ACT.	RI
8P02360003	400	3/8"	211	194	95	73	210	35	37	SR 75	3745
8P02360004	350	1/2"	214	196	95	83	210	37	40	SR 75	3745
8P02360005	350	3/4"	253	230	123	95	275	45	52	SR 100	3742
8P02360006	350	1"	263	234	123	112	275	55	60	SR 100	3742

