

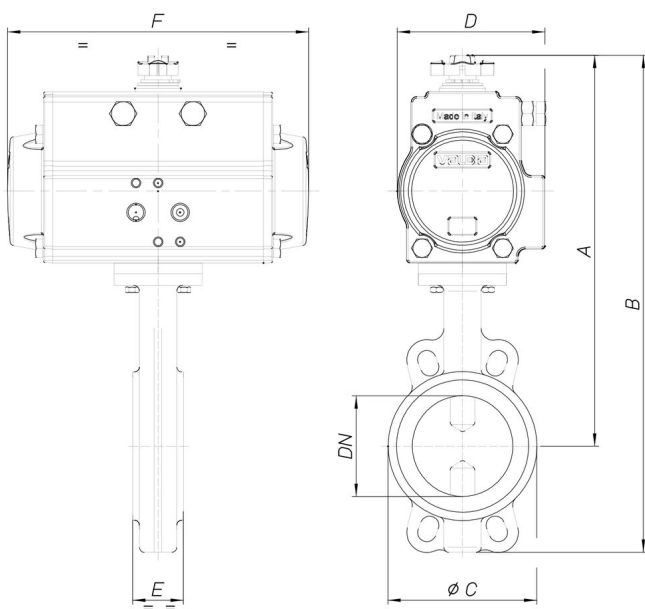

8P019600

Butterfly valve Wafer type PN16 (from DN50 to DN300), PN10 (from DN350 to DN600), body in cast iron GG25+ epoxy painting, disc GGG40 nickeled, EPDM [Valpres art. 600104] or NBR [Valpres art. 600117] seat from DN50 to DN300, EPDM seat art. 905276 from DN350 to DN600.

Technical specifications



MOD	PN	A	B	Ø C	D	E	F	ACT.	RI
8P01960010	16	266	338	100	81	43	164	SR 63	3843
8P01960012	16	279	357	120	81	46	164	SR 63	3843
8P01960014	16	312	401	127	106	46	241	SR 85	3844
8P01960018	16	328	430	161	106	52	241	SR 85	3840
8P01960019	16	354	477	190	123	56	275	SR 100	3846
8P01960020	16	366	504	215	123	56	275	SR 115	4450
8P01960021	16	469	637	268	164	60	435	SR 160	3848
8P01960077	16	524	731	325	186	68	500	SR 160	3867
8P01960078	16	672	915	375	213	78	493	SR 200	3309