

8P010900

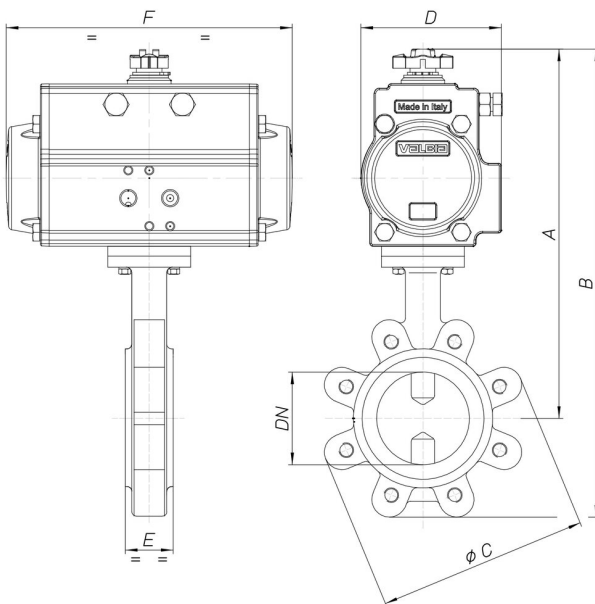

Butterfly valve Lug type PN16, (from DN40 to DN300)
 PN10 (from DN350 to DN600) body in cast iron
 GGG40+ epoxy painting, disc AISI 316, EPDM [Valpres
 art. 600205] or NBR [Valpres art. 600230] seat from
 DN40 to DN300, EPDM seat art. 905262 from DN350 to
 DN600.

Technical specifications



MOD	PN	A	B	ØC	D	E	F	ACT.	RI
8P01090008	16	224	294	145	71	33	141	DA 52	3836
8P01090010	16	255	326	165	71	43	141	DA 52	3836
8P01090012	16	267	345	185	71	46	141	DA 52	3836
8P01090014	16	281	370	200	81	46	164	DA 63	3838
8P01090018	16	315	417	220	95	52	210	DA 75	3839
8P01090019	16	341	464	250	106	56	241	DA 85	3840
8P01090020	16	355	493	285	106	56	241	DA 85	3841
8P01090021	16	434	602	340	137	60	333	DA 115	3965
8P01090077	16	482	689	405	148	68	372	DA 125	3865
8P01090078	16	541	784	460	164	78	435	DA 140	3868