



## 8P110100

2 way Wafer ball valve [Valpres art. 721V00 DN15 to DN100 (DN65 and DN100 only PN16) art.721V78 DN65 and DN100 only PN40] flanged PN16/40, stainless steel A351-CF8M, full bore, EN 558 basic series 100, metric thread, V-Pack stem seal, Fire Safe, Antistatic Device.

**NEW**

### Technical specifications

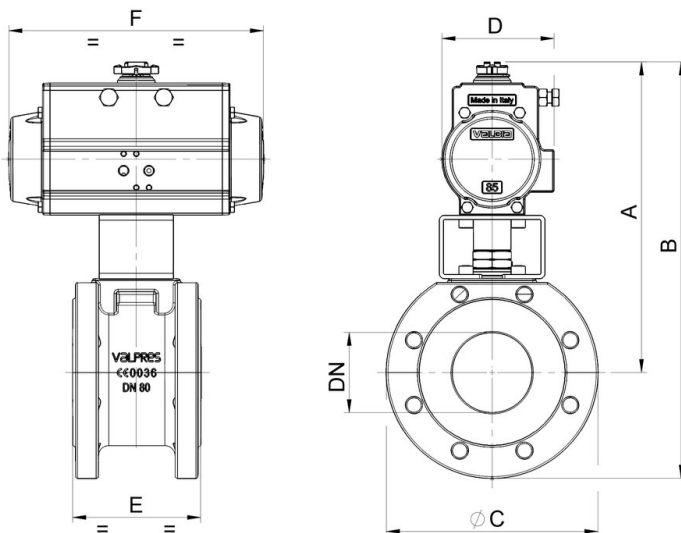

| <b>MOD</b> | <b>PN</b> | <b>A</b> | <b>B</b> | <b>ØC</b> | <b>D</b> | <b>E</b> | <b>F</b> | <b>ACT.</b> | <b>RI</b> |
|------------|-----------|----------|----------|-----------|----------|----------|----------|-------------|-----------|
| 8P11010004 | 16-40     | 186      | 233      | 95        | 71       | 36       | 141      | DA 32       | 5343      |
| 8P11010005 | 16-40     | 202      | 254      | 105       | 81       | 39       | 164      | DA 52       | 5344      |
| 8P11010006 | 16-40     | 210      | 267      | 115       | 81       | 44       | 164      | DA 52       | 3542      |
| 8P11010007 | 16-40     | 214      | 284      | 140       | 81       | 52       | 164      | DA 52       | 3521      |
| 8P11010008 | 16-40     | 267      | 342      | 150       | 81       | 64       | 241      | DA 63       | 3521      |
| 8P11010010 | 16-40     | 288      | 371      | 165       | 123      | 83       | 275      | DA 75       | 3526      |
| 8P11010012 | 16        | 335      | 427      | 185       | 137      | 105      | 333      | DA 85       | 3522      |
| 8P11010014 | 40        | 335      | 427      | 185       | 137      | 105      | 333      | DA 85       | 5345      |
| 8P11010018 | 16-40     | 353      | 453      | 200       | 148      | 121      | 372      | DA 100      | 3522      |