

8P026500

2 way Wafer ball valve [Valpres art. 720184] stainless steel AISI 316, Fire Safe, Antistatic Device, classified ATEX Ex II 2 G/D c T3.

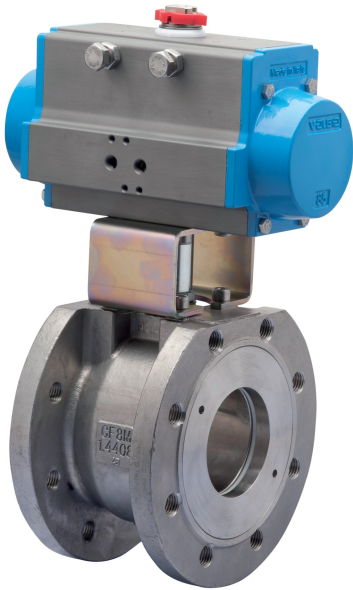

Technical specifications

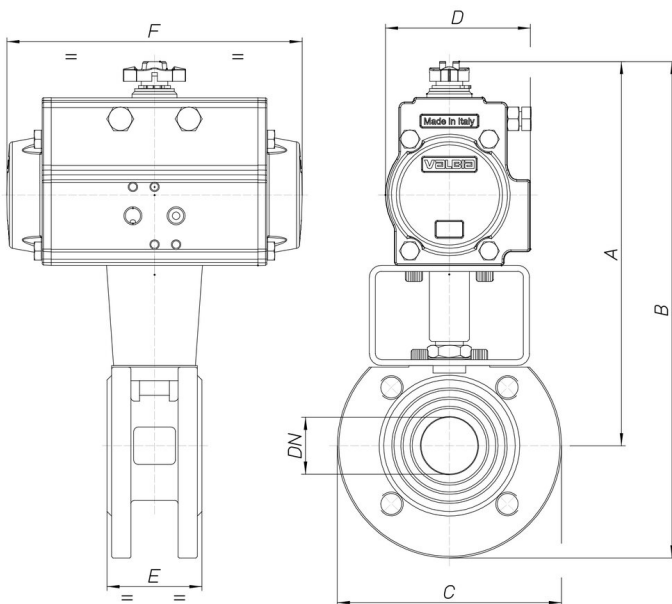

MOD	PN	A	B	C	D	E	F	ACT.	RI
8P02650004	16	147	192	90	45	35	110	DA 32	3012
8P02650005	16	188	238	100	71	40	141	DA 52	3013
8P02650006	16	208	253	115	81	46	164	DA 63	3007
8P02650007	16	212	282	140	81	54	164	DA 63	3048
8P02650008	16	245	320	150	95	64	210	DA 75	3009
8P02650010	16	253	336	165	95	82	210	DA 75	3009
8P02650012	16	298	390	185	123	103	275	DA 100	3003
8P02650014	16	305	405	200	123	122	275	DA 100	3003
8P02650018	16	375	485	220	137	152	333	DA 115	3005
8P02650019	16	398	523	250	137	196	333	DA 115	3005
8P02650020	16	475	599	285	164	232	435	DA 140	3039