

8P026600

2 way Wafer ball valve [Valpres art. 720184] stainless steel AISI 316, Fire Safe, Antistatic Device, classified ATEX Ex II 2 G/D c T3.

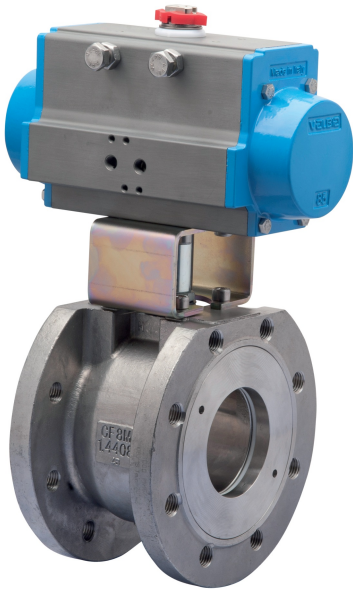

Technical specifications

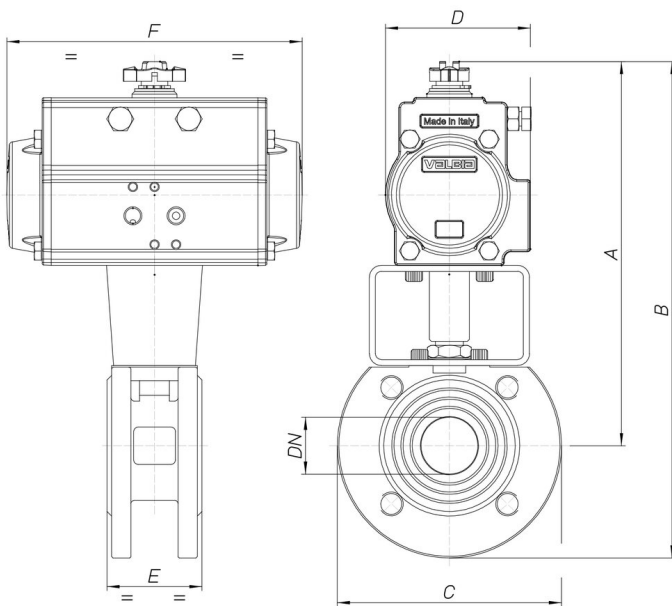

| MOD | PN | A | B | C | D | E | F | ACT. | RI |
|------------|-----------|----------|----------|----------|----------|----------|----------|-------------|-----------|
| 8P02660004 | 16 | 183 | 228 | 90 | 71 | 35 | 141 | SR52 | 3780 |
| 8P02660005 | 16 | 218 | 268 | 100 | 95 | 40 | 210 | SR75 | 5349 |
| 8P02660006 | 16 | 225 | 283 | 115 | 95 | 46 | 210 | SR75 | 3880 |
| 8P02660007 | 16 | 230 | 299 | 140 | 95 | 54 | 210 | SR75 | 3881 |
| 8P02660008 | 16 | 272 | 347 | 150 | 123 | 64 | 275 | SR100 | 3009 |
| 8P02660010 | 16 | 281 | 363 | 165 | 123 | 82 | 275 | SR100 | 3009 |
| 8P02660012 | 16 | 364 | 457 | 185 | 148 | 103 | 372 | SR125 | 3010 |
| 8P02660014 | 16 | 371 | 471 | 200 | 148 | 122 | 372 | SR125 | 3010 |
| 8P02660018 | 16 | 410 | 520 | 220 | 164 | 152 | 435 | SR140 | 3037 |
| 8P02660019 | 16 | 456 | 581 | 250 | 186 | 196 | 500 | SR160 | 3037 |
| 8P02660020 | 16 | 513 | 656 | 285 | 213 | 232 | 493 | SR180 | 3040 |