

## 8P111000



2 way Wafer ball valve [Valpres art.722V00 DN15 to DN100 (DN65 and DN100 only PN16) art.722V08 DN65 and DN100 only PN40] flanged PN16/40, carbon steel A105, full bore, EN 558 basic series 100, metric thread, V-Pack stem seal, Fire Safe, Antistatic Device.

**NEW**

### Technical specifications

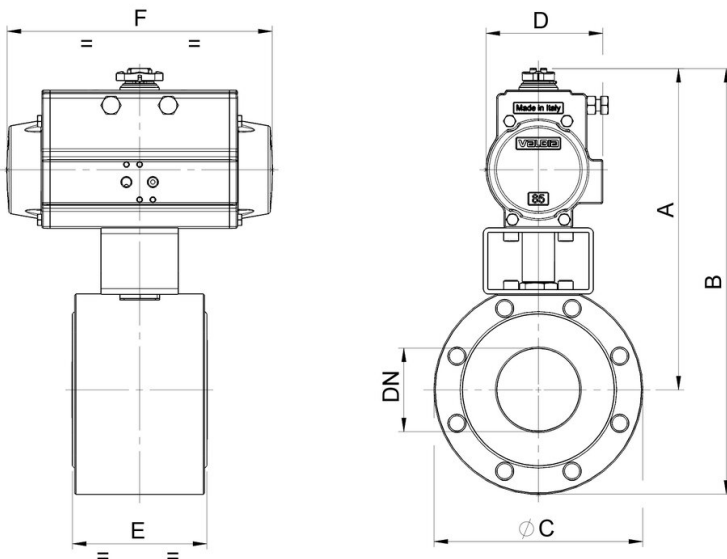

<b>MOD</b>	<b>PN</b>	<b>A</b>	<b>B</b>	<b>ØC</b>	<b>D</b>	<b>E</b>	<b>F</b>	<b>ACT.</b>	<b>RI</b>
8P11100004	16-40	149	194	95	45	36	110	DA 32	5343
8P11100005	16-40	190	240	105	71	39	141	DA 52	5344
8P11100006	16-40	198	253	115	71	44	141	DA 52	3542
8P11100007	16-40	202	267	140	71	52	141	DA 52	3521
8P11100008	16-40	235	305	150	81	64	164	DA 63	3521
8P11100010	16-40	261	336	165	95	83	210	DA 75	3526
8P11100012	16	288	378	185	106	105	241	DA 85	3522
8P11100014	40	288	378	185	106	105	241	DA 85	5345
8P11100018	16-40	294	389	200	106	121	241	DA 100	3552