

8E164

3-way ball valve type "COMBI-SFER", [Valpres Art. 776601 (L) Art. 776600 (T)], "L" or "T" ported, with 4 seats, PN16 flanged, carbon steel ASTM A105, full bore, with electric actuator.

Technical specifications

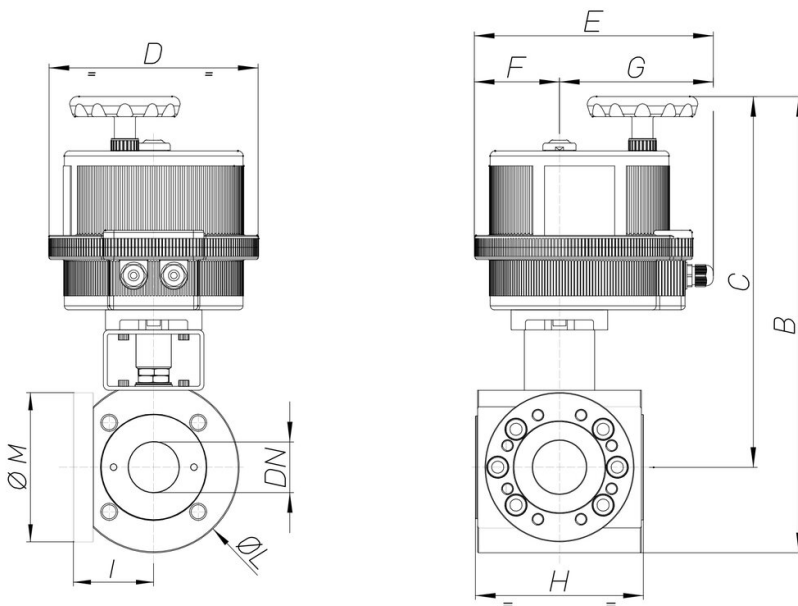

MOD	PN	B	C	D	E	F	G	H	I	ØL	ØM	ACT.	RI
8E16400104	16	271	227	123	163	43	121	99	35	88	/	VB 015	4408
8E16400204	16	271	227	123	163	43	121	99	35	88	/	VB 015	4408
8E16400404	16	271	227	123	163	43	121	99	35	88	/	VB 015	4408
8E16400105	16	342	292	157	191	61	130	108	40	100	/	VB 030	3520
8E16400205	16	342	292	157	191	61	130	108	40	100	/	VB 030	3520
8E16400405	16	342	292	157	191	61	130	108	40	100	/	VB 030	3520
8E16400106	16	352	297	157	191	61	130	115	41,5	109	/	VB 030	3520
8E16400206	16	352	297	157	191	61	130	115	41,5	109	/	VB 030	3520
8E16400406	16	352	297	157	191	61	130	115	41,5	109	/	VB 030	3520
8E16400107	16	402	337	185	215	68	147	140	52,5	133	/	VB 060	4416
8E16400207	16	402	337	185	215	68	147	140	52,5	133	/	VB 060	4416
8E16400407	16	402	337	185	215	68	147	140	52,5	133	/	VB 060	4416
8E16400108	16	419	344	185	215	68	147	150	56,5	150	/	VB 060	4039
8E16400208	16	419	344	185	215	68	147	150	56,5	150	/	VB 060	4039
8E16400408	16	419	344	185	215	68	147	150	56,5	150	/	VB 060	4039
8E16400110	16	454	369	211	237	84	153	167	62	168	/	VB 110	3522
8E16400210	16	454	369	211	237	84	153	167	62	168	/	VB 110	3522
8E16400410	16	454	369	211	237	84	153	167	62	168	/	VB 110	3522
8E16400112	16	486	382	211	237	84	153	185	85	208	/	VB 190	4411
8E16400212	16	486	382	211	237	84	153	185	85	208	/	VB 190	4411
8E16400412	16	486	382	211	237	84	153	185	85	208	/	VB 190	4411
8E16400114	16	536	421	222	247	77	170	216	127	229	212	VB 270	4412
8E16400214	16	536	421	222	247	77	170	216	127	229	212	VB 270	4412
8E16400414	16	536	421	222	247	77	170	216	127	229	212	VB 270	4412
8E16400118	16	582	443	222	247	77	170	244	150	278	239	VB 270	4412
8E16400218	16	582	443	222	247	77	170	244	150	278	239	VB 270	4412
8E16400418	16	582	443	222	247	77	170	244	150	278	239	VB 270	4412