

8E027

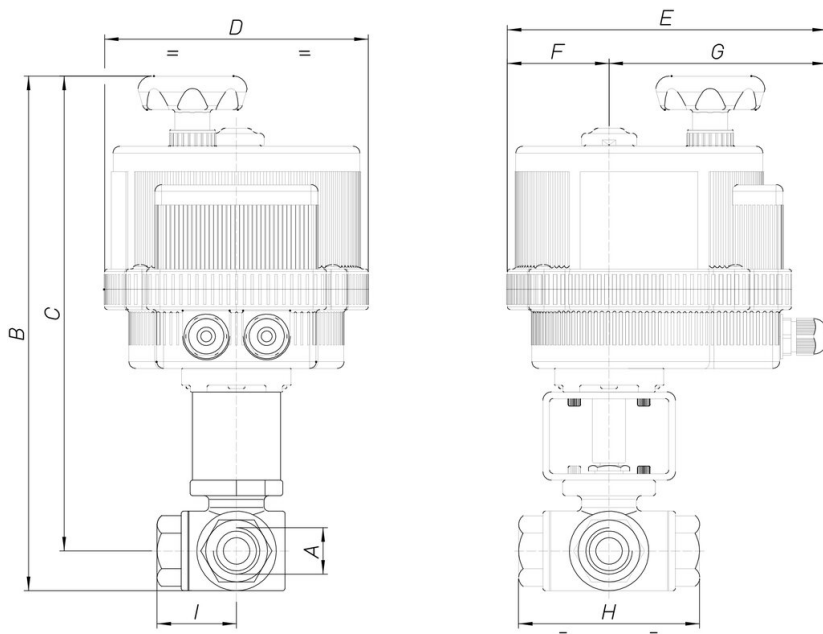

3 way ball valve [Valpres art. 772000 (T) - 775000 (L)] investment casted, stainless steel AISI 316-CF8M, threaded F/F/F with 4 seats, reduced bore, "T" or "L" port, with electric actuator series 85.

Technical specifications



MOD	PN	A	B	C	D	E	F	G	H	I	ACT.	RI
8E02700102	63	1/4"	235	219	123	164	43	121	70	35	VB 015	3760
8E02700202	63	1/4"	235	219	123	164	43	121	70	35	VB 015	3760
8E02700402	63	1/4"	235	219	123	164	43	121	70	35	VB 015	3760
8E02700103	63	3/8"	235	219	123	164	43	121	70	35	VB 015	3760
8E02700203	63	3/8"	235	219	123	164	43	121	70	35	VB 015	3760
8E02700403	63	3/8"	235	219	123	164	43	121	70	35	VB 015	3760
8E02700104	63	1/2"	239	223	123	164	43	121	76	38	VB 015	3760
8E02700204	63	1/2"	239	223	123	164	43	121	76	38	VB 015	3760
8E02700404	63	1/2"	239	223	123	164	43	121	76	38	VB 015	3760
8E02700105	63	3/4"	306	285	157	191	61	130	87	45	VB 030	3761
8E02700205	63	3/4"	306	285	157	191	61	130	87	45	VB 030	3761
8E02700405	63	3/4"	306	285	157	191	61	130	87	45	VB 030	3761
8E02700106	63	1"	314	289	157	191	61	130	103	52	VB 030	4034
8E02700206	63	1"	314	289	157	191	61	130	103	52	VB 030	4034
8E02700406	63	1"	314	289	157	191	61	130	103	52	VB 030	4034
8E02700107	63	1"1/4	322	295	157	191	61	130	118	58	VB 030	4035
8E02700207	63	1"1/4	322	295	157	191	61	130	118	58	VB 030	4035
8E02700407	63	1"1/4	322	295	157	191	61	130	118	58	VB 030	4035
8E02700108	63	1"1/2	381	347	211	237	84	153	126	63	VB 110	3764
8E02700208	63	1"1/2	381	347	211	237	84	153	126	63	VB 110	3764
8E02700408	63	1"1/2	381	347	211	237	84	153	126	63	VB 110	3764
8E02700110	63	2"	396	356	211	237	84	153	149	75	VB 110	3003
8E02700210	63	2"	396	356	211	237	84	153	149	75	VB 110	3003
8E02700410	63	2"	396	356	211	237	84	153	149	75	VB 110	3003