

8E023

3 way flanged polished ball valve, from ingot, stainless steel AISI 316, full bore, "T" or "L" port, with electric actuator.

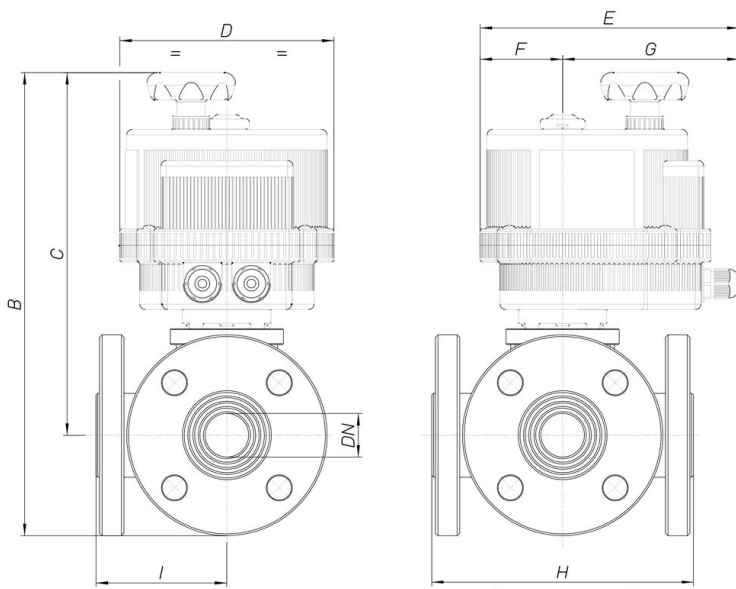

Technical specifications



MOD	PN	B	C	D	E	F	G	H	I	ACT.
8E02300103	40	234	189	123	164	43	121	120	60	VB 015
8E02300203	40	234	189	123	164	43	121	120	60	VB 015
8E02300403	40	234	189	123	164	43	121	120	60	VB 015
8E02300104	40	239	191	123	164	43	121	130	65	VB 015
8E02300204	40	239	191	123	164	43	121	130	65	VB 015
8E02300404	40	239	191	123	164	43	121	130	65	VB 015
8E02300105	40	297	245	157	191	61	130	140	70	VB 030 *
8E02300205	40	297	245	157	191	61	130	140	70	VB 030 *
8E02300405	40	297	245	157	191	61	130	140	70	VB 030 *
8E02300106	40	307	249	157	191	61	130	150	75	VB 030 *
8E02300206	40	307	249	157	191	61	130	150	75	VB 030 *
8E02300406	40	307	249	157	191	61	130	150	75	VB 030 *
8E02300107	40	367	297	185	215	68	147	180	90	VB 060
8E02300207	40	367	297	185	215	68	147	180	90	VB 060
8E02300407	40	367	297	185	215	68	147	180	90	VB 060
8E02300108	40	379	304	185	215	68	147	200	100	VB 060
8E02300208	40	379	304	185	215	68	147	200	100	VB 060
8E02300408	40	379	304	185	215	68	147	200	100	VB 060
8E02300110	25	389	307	185	215	68	147	220	110	VB 060 *
8E02300210	25	389	307	185	215	68	147	220	110	VB 060 *
8E02300410	25	389	307	185	215	68	147	220	110	VB 060 *
8E02300112	16	426	334	211	237	84	153	240	120	VB 110
8E02300212	16	426	334	211	237	84	153	240	120	VB 110
8E02300412	16	426	334	211	237	84	153	240	120	VB 110
8E02300114	16	448	348	211	237	84	153	260	130	VB 190
8E02300214	16	448	348	211	237	84	153	260	130	VB 190
8E02300414	16	448	348	211	237	84	153	260	130	VB 190
8E02300118	16	475	365	222	247	77	170	300	150	VB 350
8E02300218	16	475	365	222	247	77	170	300	150	VB 350
8E02300418	16	475	365	222	247	77	170	300	150	VB 350