

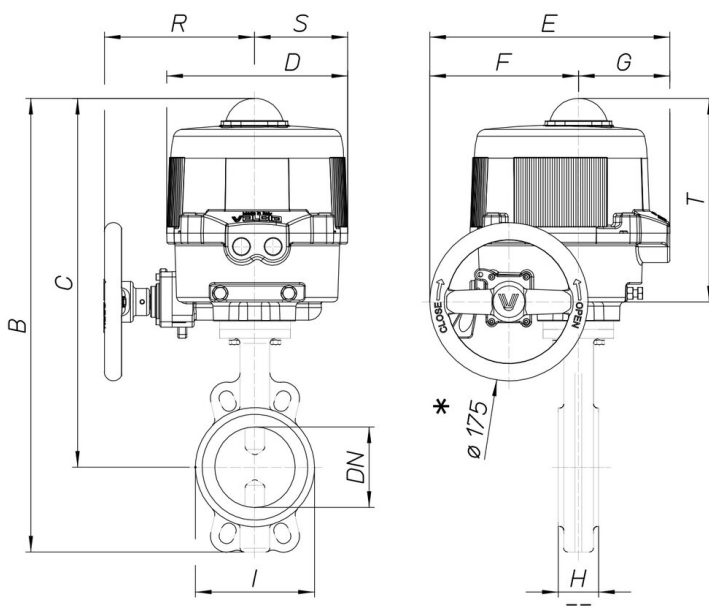

8M096

Butterfly valve Wafer type PN16 (from DN50 to DN300), PN10 (from DN350 to DN600), body in cast iron GG25+epoxy painting, disc GGG40 nicked, EPDM [Valpres art. 600104] or NBR [Valpres art. 600117] seat from DN50 to DN300, EPDM seat art. 905276 from DN350 to DN600.

Technical specifications



MOD	PN	B	C	D	E	F	G	H	I	R	S	T	ACT.	KIT
8M09600110	16	424	352	161	187	63	124	43	100	-	-	-	VB030M	RI3836
8M09600210	16	424	352	161	187	63	124	43	100	-	-	-	VB030M	RI3836
8M09600410	16	424	352	161	187	63	124	43	100	-	-	-	VB030M	RI3836
8M09600112	16	443	365	161	187	63	124	46	120	-	-	-	VB030M	RI3836
8M09600212	16	443	365	161	187	63	124	46	120	-	-	-	VB030M	RI3836
8M09600412	16	443	365	161	187	63	124	46	120	-	-	-	VB030M	RI3836
8M09600114	16	477	387	176	197	63	134	46	127	-	-	-	VB060M	RI3883
8M09600214	16	477	387	176	197	63	134	46	127	-	-	-	VB060M	RI3883
8M09600414	16	477	387	176	197	63	134	46	127	-	-	-	VB060M	RI3883
8M09600118	16	505	403	176	197	63	134	52	161	-	-	-	VB060M	RI3884
8M09600218	16	505	403	176	197	63	134	52	161	-	-	-	VB060M	RI3884
8M09600418	16	505	403	176	197	63	134	52	161	-	-	-	VB060M	RI3884
8M09600119	16	565	442	200	266	165	101	56	190	167	103	225	VB110M	RI3840
8M09600219	16	565	442	200	266	165	101	56	190	167	103	225	VB110M	RI3840
8M09600419	16	565	442	200	266	165	101	56	190	167	103	225	VB110M	RI3840
8M09600120	16	593	455	200	266	165	101	56	512	167	103	225	VB190M	RI3847
8M09600220	16	593	455	200	266	165	101	56	512	167	103	225	VB190M	RI3847
8M09600420	16	593	455	200	266	165	101	56	512	167	103	225	VB190M	RI3847
8M09600121	16	658	490	212	279	184	95	60	568	166	109	226	VB270M	RI3965
8M09600221	16	658	490	212	279	184	95	60	568	166	109	226	VB270M	RI3965
8M09600421	16	658	490	212	279	184	95	60	568	166	109	226	VB270M	RI3965
8M09600177	16	733	526	212	279	184	95	68	325	166	109	226	VB350M	RI3865
8M09600277	16	733	526	212	279	184	95	68	325	166	109	226	VB350M	RI3865
8M09600477	16	733	526	212	279	184	95	68	325	166	109	226	VB350M	RI3865