

8M052

3 way ball valve, 9SMnPb36, L or T port, diverting only, F/F/F threaded, for high pressure, for hydraulic oil, emulsion, gas, for particular applications refer to sales department.

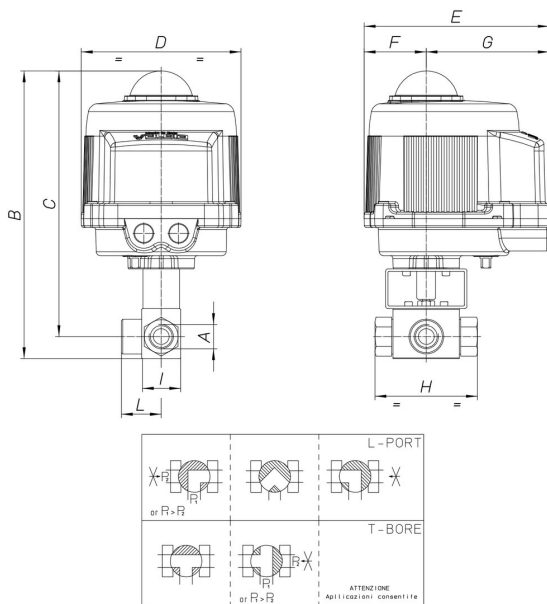

Technical specifications



MOD	PN	B	C	D	E	F	G	H	I	L	ACT.	KIT
8M05200103	400	279	261	161	187	63	124	73	35	37	VB030M	RI3740
8M05200203	400	279	261	161	187	63	124	73	35	37	VB030M	RI3740
8M05200403	400	279	261	161	187	63	124	73	35	37	VB030M	RI3740
8M05200104	350	282	264	161	187	63	124	83	37	40	VB030M	RI3740
8M05200204	350	282	264	161	187	63	124	83	37	40	VB030M	RI3740
8M05200404	350	282	264	161	187	63	124	83	37	40	VB030M	RI3740
8M05200105	350	294	271	161	187	63	124	95	45	52	VB030M	RI4037
8M05200205	350	294	271	161	187	63	124	95	45	52	VB030M	RI4037
8M05200405	350	294	271	161	187	63	124	95	45	52	VB030M	RI4037
8M05200106	350	325	296	176	197	63	134	112	55	60	VB060M	RI4038
8M05200206	350	325	296	176	197	63	134	112	55	60	VB060M	RI4038
8M05200406	350	325	296	176	197	63	134	112	55	60	VB060M	RI4038