

8M188

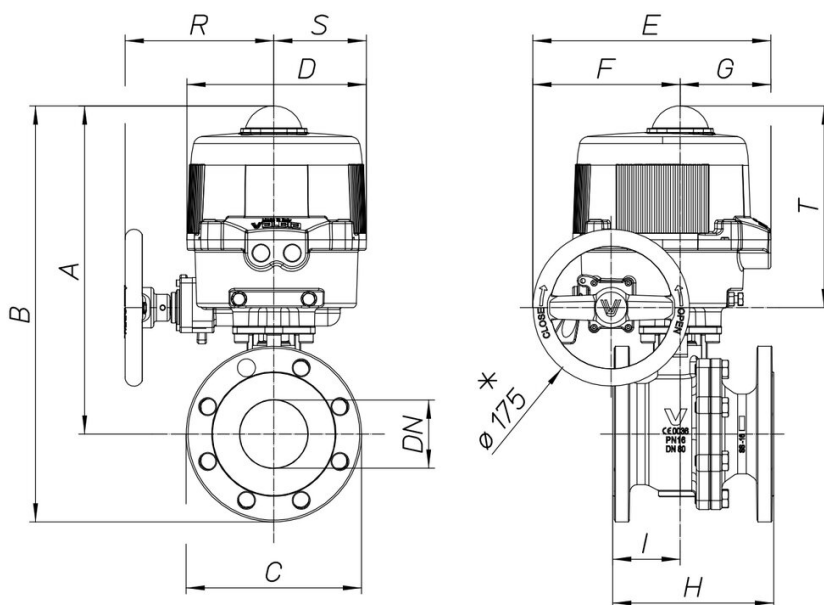

Flanged ANSI 150 stainless steel AISI 316 CF8M ball valve, full bore Split Body type [Valpres art. 766000] ISO 5211 pad direct, Fire Safe, Antistatic Device, ANSI B16.10 face to face dimension.

Technical specifications



MOD	PN	B	C	D	E	F	G	H	ØI	L	R	S	T	ACT.	RI
8M18800106	20	312	257	161	187	63	124	127	110	54	-	-	-	VB 030M	4579
8M18800206	20	312	257	161	187	63	124	127	110	54	-	-	-	VB 030M	4579
8M18800406	20	312	257	161	187	63	124	127	110	54	-	-	-	VB 030M	4579
8M18800108	20	365	300	176	197	63	134	165	130	76	-	-	-	VB 060M	4581
8M18800208	20	365	300	176	197	63	134	165	130	76	-	-	-	VB 060M	4581
8M18800408	20	365	300	176	197	63	134	165	130	76	-	-	-	VB 060M	4581
8M18800110	20	385	310	176	197	63	134	178	150	85	-	-	-	VB 060M	4581
8M18800210	20	385	310	176	197	63	134	178	150	85	-	-	-	VB 060M	4581
8M18800410	20	385	310	176	197	63	134	178	150	85	-	-	-	VB 060M	4581
8M18800114	20	461	366	200	266	165	101	203	190	93	167	103	225	VB 110M	4584
8M18800214	20	461	366	200	266	165	101	203	190	93	167	103	225	VB 110M	4584
8M18800414	20	461	366	200	266	165	101	203	190	93	167	103	225	VB 110M	4584
8M18800118	20	496	381	200	266	165	101	229	230	100	167	103	225	VB 190M	4586
8M18800218	20	496	381	200	266	165	101	229	230	100	167	103	225	VB 190M	4586
8M18800418	20	496	381	200	266	165	101	229	230	100	167	103	225	VB 190M	4586