

8P015400

Válvula de bola 3 vías "L" o "T", en acero al carbono 9SMnPb36, rosca H/H/H, para alta presión, con actuador. Idónea para aceite mineral, gas.

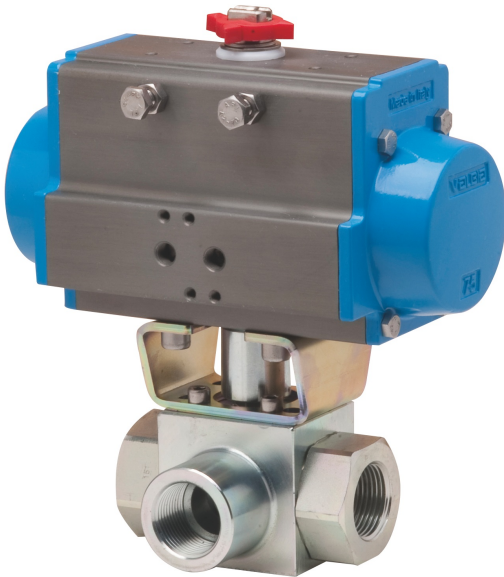

Especificaciones técnicas

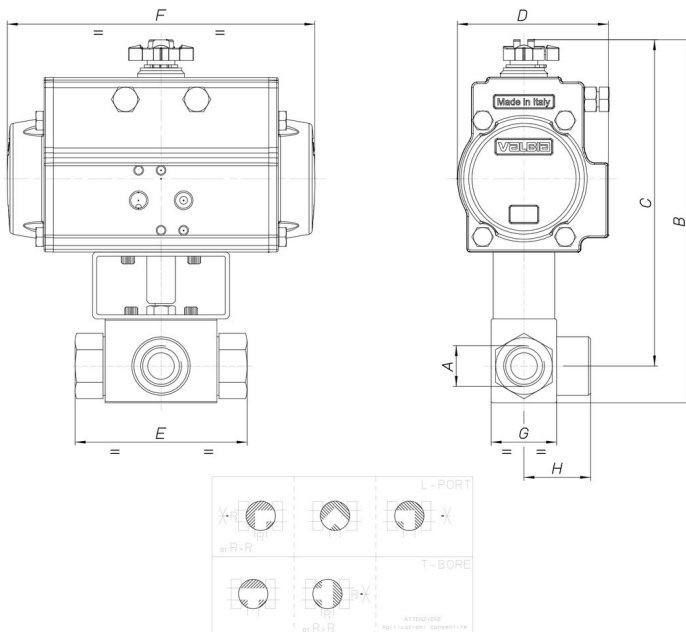

MOD	PN	A	B	C	D	E	F	G	H	ACT.	RI
8P01540003	400	3/8"	182	164	71	73	141	35	37	DA 52	3740
8P01540004	350	1/2"	196	178	81	83	164	37	40	DA 63	3741
8P01540005	350	3/4"	226	203	95	95	210	45	52	DA 75	3742
8P01540006	350	1"	236	207	95	112	210	55	60	DA 75	3742

