

8P015600

Válvula de bola 3 vías "L" o "T", en acero al carbono 9SMnPb36, rosca H/H/H, para alta presión, con actuador. Idónea para aceite mineral, gas.

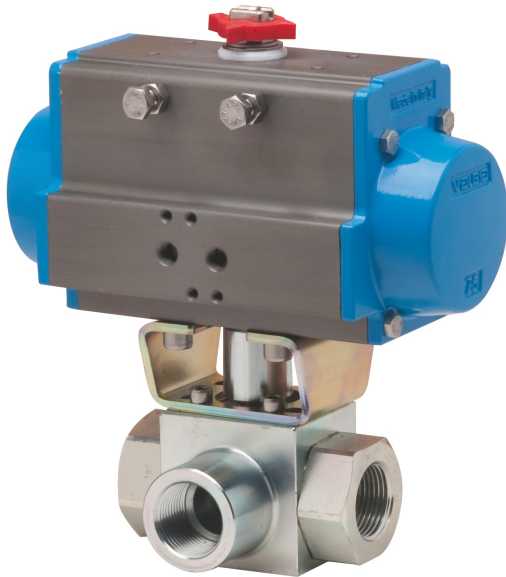

Especificaciones técnicas

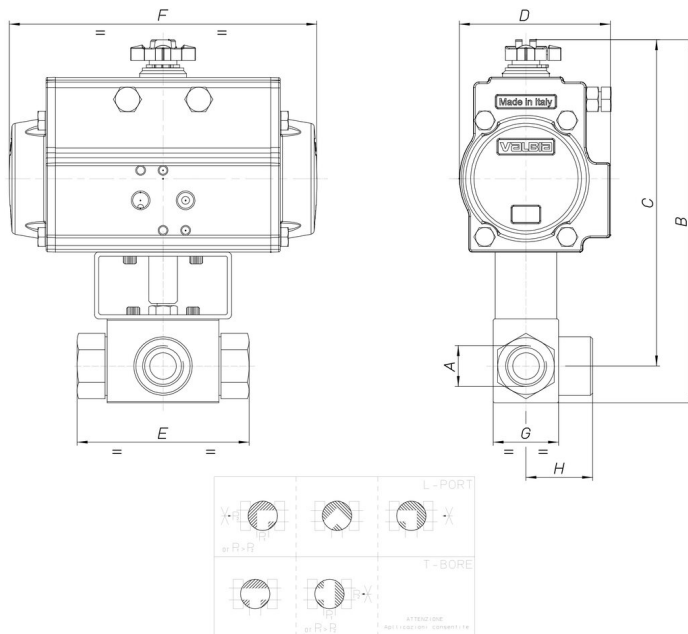

MOD	PN	A	B	C	D	E	F	G	H	ACT.	RI
8P01560003	400	3/8"	211	194	95	73	210	35	37	SR 75	3745
8P01560004	350	1/2"	214	196	95	83	210	37	40	SR 75	3745
8P01560005	350	3/4"	253	230	123	95	275	45	52	SR 100	3742
8P01560006	350	1"	263	234	123	112	275	55	60	SR 100	3742

