

8P006000

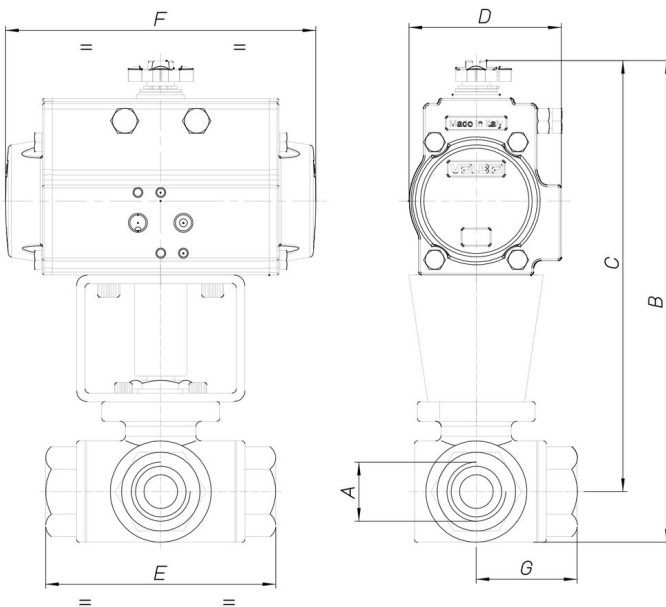

3 way ball valve [Valpres artt. 772000 (T) - 775000 (L)]
investment casted, stainless steel AISI 316-CF8M,
threaded F/F/F with 4 seats, reduced bore, T or L port.

Especificaciones técnicas



MOD	PN	A	B	C	D	E	F	G	ACT.	RI
8P00600002	63	1/4"	195	179	71	70	141	35	DA 52	3760
8P00600003	63	3/8"	195	179	71	70	141	35	DA 52	3760
8P00600004	63	1/2"	199	183	71	76	141	38	DA 52	3760
8P00600005	63	3/4"	231	210	81	87	164	45	DA 63	3770
8P00600006	63	1"	239	214	81	103	164	52	DA 63	3762
8P00600007	63	1"1/4	266	219	81	118	164	58	DA 63	3763
8P00600008	63	1"1/2	294	260	106	126	241	63	DA 85	3764
8P00600010	63	2"	309	269	106	149	241	75	DA 85	3003