

8E017

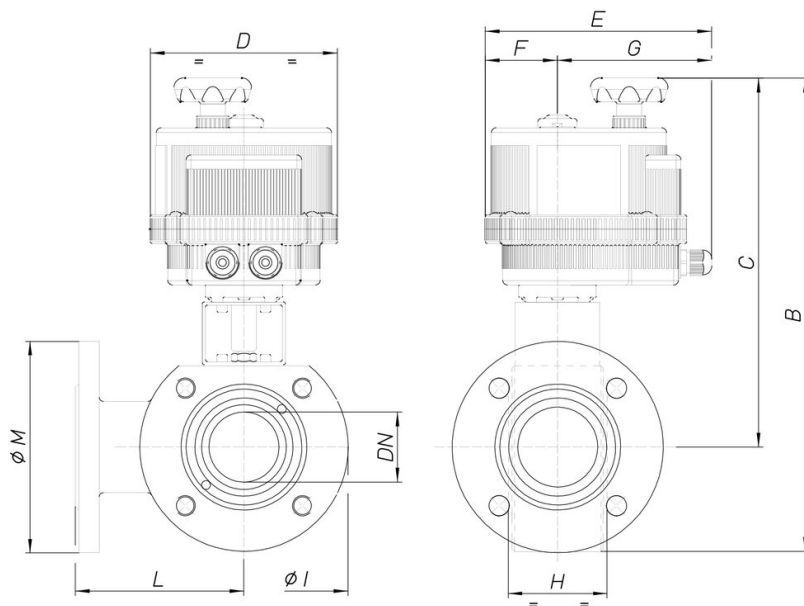

Válvula de bola tipo "WAFER" 3 vías desviadora
[Valpres Art. 776007 (L) - 776010 (T)], acero inoxidable
AISI 316, con actuador.

Especificaciones técnicas



MOD	PN	B	C	D	E	F	G	H	I	L	M	ACT.	RI
8E01700104	16	268	224	123	164	43	121	40	89	76	95	VB 015	3780
8E01700204	16	268	224	123	164	43	121	40	89	76	95	VB 015	3780
8E01700404	16	268	224	123	164	43	121	40	89	76	95	VB 015	3780
8E01700105	16	278	228	123	164	43	121	40	99	82	105	VB 015	3013
8E01700205	16	278	228	123	164	43	121	40	99	82	105	VB 015	3013
8E01700405	16	278	228	123	164	43	121	40	99	82	105	VB 015	3013
8E01700106	16	334	279	157	191	61	130	46	109	86	115	VB 030	3001
8E01700206	16	334	279	157	191	61	130	46	109	86	115	VB 030	3001
8E01700406	16	334	279	157	191	61	130	46	109	86	115	VB 030	3001
8E01700107	16	352	287	157	191	61	130	58	130	100	140	VB 030	3008
8E01700207	16	352	287	157	191	61	130	58	130	100	140	VB 030	3008
8E01700407	16	352	287	157	191	61	130	58	130	100	140	VB 030	3008
8E01700108	16	399	329	185	215	68	147	71	140	105	150	VB 060	3002
8E01700208	16	399	329	185	215	68	147	71	140	105	150	VB 060	3002
8E01700408	16	399	329	185	215	68	147	71	140	105	150	VB 060	3002
8E01700110	16	415	335	185	215	68	147	82	160	115	165	VB 060	3002
8E01700210	16	415	335	185	215	68	147	82	160	115	165	VB 060	3002
8E01700410	16	415	335	185	215	68	147	82	160	115	165	VB 060	3002
8E01700112	16	459	369	211	237	84	153	106	180	125	185	VB 110	3003
8E01700212	16	459	369	211	237	84	153	106	180	125	185	VB 110	3003
8E01700412	16	459	369	211	237	84	153	106	180	125	185	VB 110	3003
8E01700114	16	477	377	211	237	84	153	122	200	150	200	VB 110	3003
8E01700214	16	477	377	211	237	84	153	122	200	150	200	VB 110	3003
8E01700414	16	477	377	211	237	84	153	122	200	150	200	VB 110	3003
8E01700118	16	524	414	211	237	84	153	152	220	159	220	VB 190	3004
8E01700218	16	524	414	211	237	84	153	152	220	159	220	VB 190	3004
8E01700418	16	524	414	211	237	84	153	152	220	159	220	VB 190	3004