

8M260



2 way Wafer ball valve [Valpres art. 721V00 DN15 to DN100 (DN65 and DN100 only PN16) art.721V78 DN65 and DN100 only PN40] flanged PN16/40, stainless steel A351-CF8M, full bore, EN 558 basic series 100, metric thread, V-Pack stem seal, Fire Safe, Antistatic Device. With electric actuator series 85.

NEW

Especificaciones técnicas

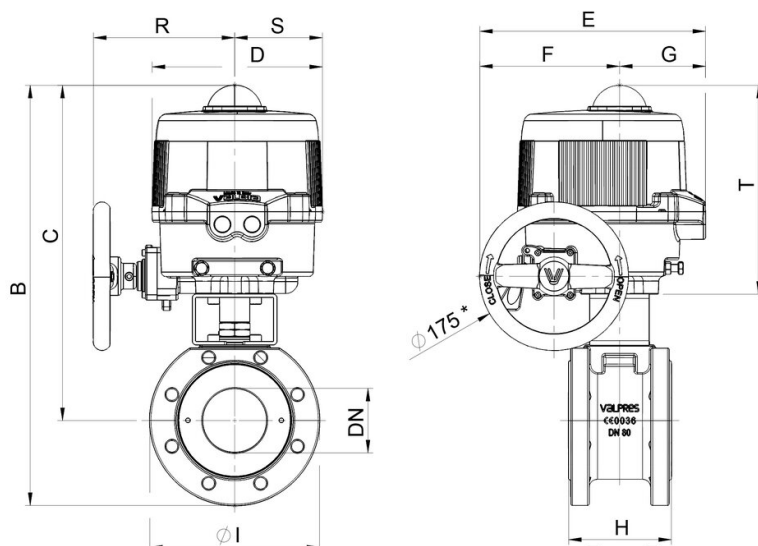

* mod.VB030M-VB060M Q10mm SENZA VOLANTINO - without handwheel

MOD	PN	B	C	D	E	F	G	H	I	R	S	T	ACT.	KIT
8M26000106	16-40	351	293	161	187	63	124	46	115	-	-	-	VB 030M	RI3542
8M26000206	16-40	351	293	161	187	63	124	46	115	-	-	-	VB 030M	RI3542
8M26000406	16-40	351	293	161	187	63	124	46	115	-	-	-	VB 030M	RI3542
8M26000107	16-40	369	299	161	187	63	124	54	140	-	-	-	VB 060M	RI3542
8M26000207	16-40	369	299	161	187	63	124	54	140	-	-	-	VB 060M	RI3542
8M26000407	16-40	369	299	161	187	63	124	54	140	-	-	-	VB 060M	RI3542
8M26000108	16-40	409	334	176	197	63	134	64	150	-	-	-	VB 060M	RI3521
8M26000208	16-40	409	334	176	197	63	134	64	150	-	-	-	VB 060M	RI3521
8M26000408	16-40	409	334	176	197	63	134	64	150	-	-	-	VB 060M	RI3521
8M26000110	16-40	425	342	176	197	63	134	82	165	-	-	-	VB 060M	RI3521
8M26000210	16-40	425	342	176	197	63	134	82	165	-	-	-	VB 060M	RI3521
8M26000410	16-40	425	342	176	197	63	134	82	165	-	-	-	VB 060M	RI3521
8M26000112	16	478	386	200	266	165	101	103	185	167	103	225	VB 110M	RI3522
8M26000212	16	478	386	200	266	165	101	103	185	167	103	225	VB 110M	RI3522
8M26000412	16	478	386	200	266	165	101	103	185	167	103	225	VB 110M	RI3522
8M26000114	40	478	386	200	266	165	101	103	185	167	103	225	VB 110M	RI5345
8M26000214	40	478	386	200	266	165	101	103	185	167	103	225	VB 110M	RI5345
8M26000414	40	478	386	200	266	165	101	103	185	167	103	225	VB 110M	RI5345
8M26000118	16-40	493	393	200	266	165	101	122	200	167	103	225	VB 190M	RI3552
8M26000218	16-40	493	393	200	266	165	101	122	200	167	103	225	VB 190M	RI3552
8M26000418	16-40	493	393	200	266	165	101	122	200	167	103	225	VB 190M	RI3552