

8E018

Válvula de bola producida de lingote, brillante, 3 vías "T" o "L", 4 juntas en PTFE virgen, acero inoxidable AISI 316, ataque ISO 228 H/H/H, con actuador.

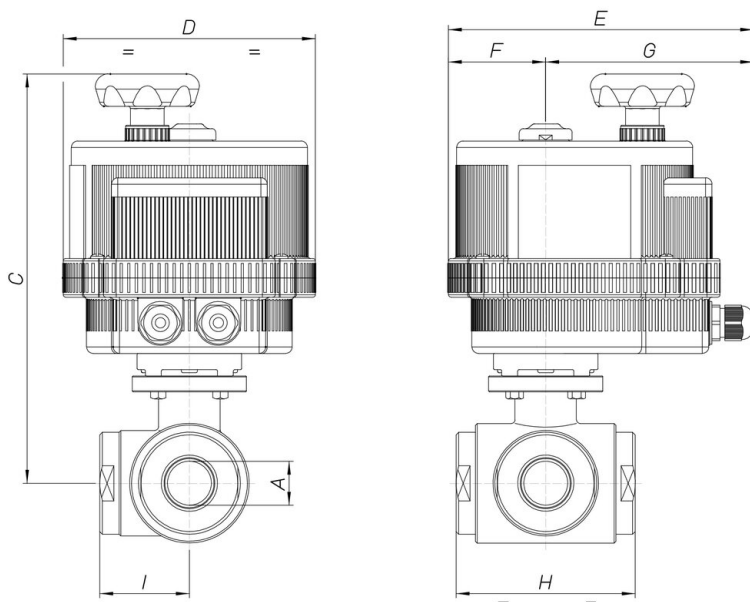

Especificaciones técnicas



MOD	PN	A	C	D	E	F	G	H	I	ACT.
8E01800102	40	1/4"	189	123	164	43	121	72	36	VB 015
8E01800202	40	1/4"	189	123	164	43	121	72	36	VB 015
8E01800402	40	1/4"	189	123	164	43	121	72	36	VB 015
8E01800103	40	3/8"	189	123	164	43	121	72	36	VB 015
8E01800203	40	3/8"	189	123	164	43	121	72	36	VB 015
8E01800403	40	3/8"	189	123	164	43	121	72	36	VB 015
8E01800104	40	1/2"	191	123	164	43	121	82	41	VB 015
8E01800204	40	1/2"	191	123	164	43	121	82	41	VB 015
8E01800404	40	1/2"	191	123	164	43	121	82	41	VB 015
8E01800105	40	3/4"	245	157	191	61	130	92	46	VB 030 *
8E01800205	40	3/4"	245	157	191	61	130	92	46	VB 030 *
8E01800405	40	3/4"	245	157	191	61	130	92	46	VB 030 *
8E01800106	40	1"	249	157	191	61	130	102	51	VB 030*
8E01800206	40	1"	249	157	191	61	130	102	51	VB 030*
8E01800406	40	1"	249	157	191	61	130	102	51	VB 030*
8E01800107	40	1"1/4	297	185	215	68	147	118	59	VB 060
8E01800207	40	1"1/4	297	185	215	68	147	118	59	VB 060
8E01800407	40	1"1/4	297	185	215	68	147	118	59	VB 060
8E01800108	40	1"1/2	304	185	215	68	147	134	67	VB 060 *
8E01800208	40	1"1/2	304	185	215	68	147	134	67	VB 060 *
8E01800408	40	1"1/2	304	185	215	68	147	134	67	VB 060 *
8E01800110	25	2"	307	185	215	68	147	144	72	VB 060 *
8E01800210	25	2"	307	185	215	68	147	144	72	VB 060 *
8E01800410	25	2"	307	185	215	68	147	144	72	VB 060 *
8E01800112	25	2"1/2	334	211	237	84	153	160	80	VB 110
8E01800212	25	2"1/2	334	211	237	84	153	160	80	VB 110
8E01800412	25	2"1/2	334	211	237	84	153	160	80	VB 110
8E01800114	16	3"	348	211	237	84	153	200	100	VB 190
8E01800214	16	3"	348	211	237	84	153	200	100	VB 190
8E01800414	16	3"	348	211	237	84	153	200	100	VB 190
8E01800118	16	4"	365	222	247	77	170	240	120	VB 350
8E01800218	16	4"	365	222	247	77	170	240	120	VB 350
8E01800418	16	4"	365	222	247	77	170	240	120	VB 350