

## 8E096

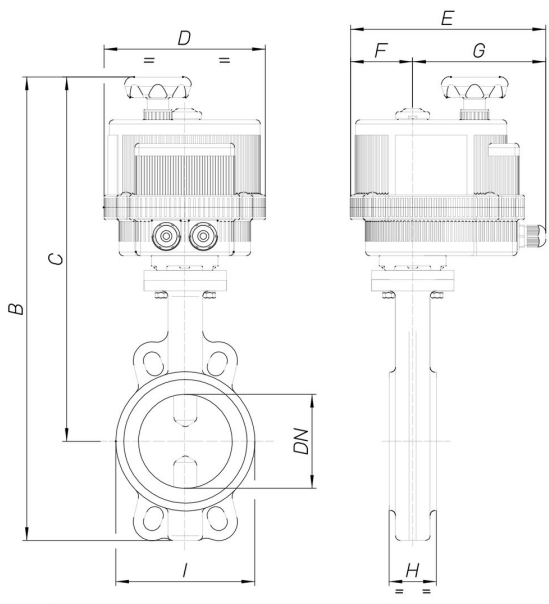

Butterfly valve Wafer type PN16 (from DN50 to DN300), PN10 (from DN350 to DN600), body in cast iron GG25+ epoxy painting, disc GGG40 nickeled, EPDM [Valpres art. 600104] or NBR [Valpres art. 600117] seat from DN50 to DN300, EPDM seat art. 905276 from DN350 to DN600.

### Especificaciones técnicas



MOD	PN	B	C	D	E	F	G	H	I	ACT.	RI
8E09600110	16	413	341	157	191	61	130	43	100	VB 030	3836
8E09600210	16	413	341	157	191	61	130	43	100	VB 030	3836
8E09600410	16	413	341	157	191	61	130	43	100	VB 030	3836
8E09600112	16	432	354	157	191	61	130	46	120	VB 030	3836
8E09600212	16	432	354	157	191	61	130	46	120	VB 030	3836
8E09600412	16	432	354	157	191	61	130	46	120	VB 030	3836
8E09600114	16	472	383	185	215	68	147	46	127	VB 060	3883
8E09600214	16	472	383	185	215	68	147	46	127	VB 060	3883
8E09600414	16	472	383	185	215	68	147	46	127	VB 060	3883
8E09600118	16	500	398	185	215	68	147	52	161	VB 060	3884
8E09600218	16	500	398	185	215	68	147	52	161	VB 060	3884
8E09600418	16	500	398	185	215	68	147	52	161	VB 060	3884
8E09600119	16	551	428	211	237	84	153	56	190	VB 110	3840
8E09600219	16	551	428	211	237	84	153	56	190	VB 110	3840
8E09600419	16	551	428	211	237	84	153	56	190	VB 110	3840
8E09600120	16	579	441	211	237	84	153	56	215	VB 190	3847
8E09600220	16	579	441	211	237	84	153	56	215	VB 190	3847
8E09600420	16	579	441	211	237	84	153	56	215	VB 190	3847
8E09600121	16	644	476	222	247	77	170	60	268	VB 270	3965
8E09600221	16	644	476	222	247	77	170	60	268	VB 270	3965
8E09600421	16	644	476	222	247	77	170	60	268	VB 270	3965
8E09600177	16	719	512	222	247	77	170	68	325	VB 350	3865
8E09600277	16	719	512	222	247	77	170	68	325	VB 350	3865
8E09600477	16	719	512	222	247	77	170	68	325	VB 350	3865