

8M017

3 way Wafer ball valve diverting [Valpres art. 776010 (T) - 776007 (L)] T or L port, 2 seats, flanged PN16, stainless steel AISI 316 reduced bore.

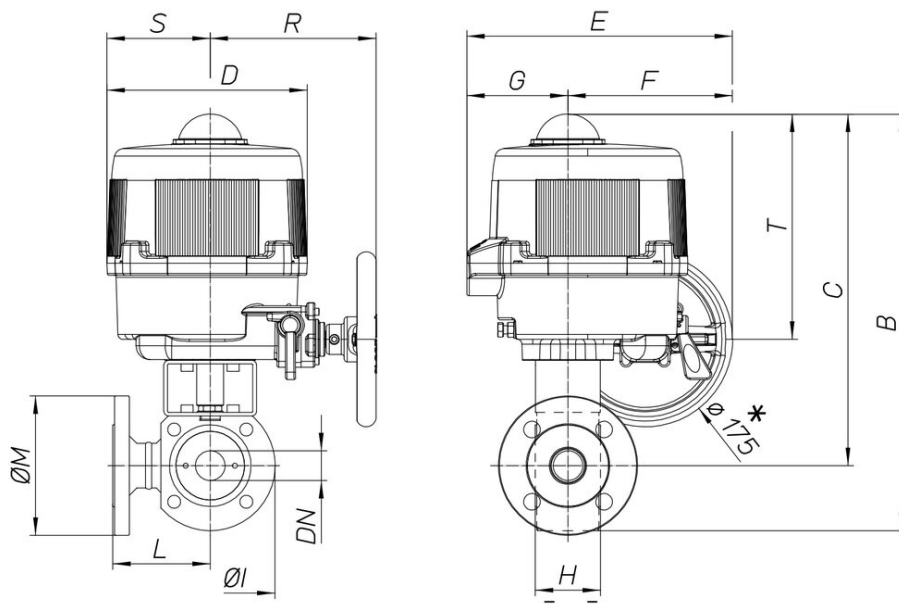

Especificaciones técnicas



MOD	PN	B	C	D	E	F	G	H	ØI	L	ØM	R	S	T	ACT.	RI
8M01700106	16	345	290	161	187	63	124	46	109	86	115	-	-	-	VB 030M	3001
8M01700206	16	345	290	161	187	63	124	46	109	86	115	-	-	-	VB 030M	3001
8M01700406	16	345	290	161	187	63	124	46	109	86	115	-	-	-	VB 030M	3001
8M01700107	16	363	298	161	187	63	124	58	130	105	140	-	-	-	VB 030M	3008
8M01700207	16	363	298	161	187	63	124	58	130	105	140	-	-	-	VB 030M	3008
8M01700407	16	363	298	161	187	63	124	58	130	105	140	-	-	-	VB 030M	3008
8M01700108	16	404	334	176	197	63	134	71	140	110	150	-	-	-	VB 060M	3002
8M01700208	16	404	334	176	197	63	134	71	140	110	150	-	-	-	VB 060M	3002
8M01700408	16	404	334	176	197	63	134	71	140	110	150	-	-	-	VB 060M	3002
8M01700110	16	420	340	176	197	63	134	82	160	115	165	-	-	-	VB 060M	3002
8M01700210	16	420	340	176	197	63	134	82	160	115	165	-	-	-	VB 060M	3002
8M01700410	16	420	340	176	197	63	134	82	160	115	165	-	-	-	VB 060M	3002
8M01700112	16	473	383	200	266	165	101	106	180	125	185	167	103	225	VB 110M	3003
8M01700212	16	473	383	200	266	165	101	106	180	125	185	167	103	225	VB 110M	3003
8M01700412	16	473	383	200	266	165	101	106	180	125	185	167	103	225	VB 110M	3003
8M01700114	16	491	391	200	266	165	101	122	200	150	200	167	103	225	VB 110M	3003
8M01700214	16	491	391	200	266	165	101	122	200	150	200	167	103	225	VB 110M	3003
8M01700414	16	491	391	200	266	165	101	122	200	150	200	167	103	225	VB 110M	3003
8M01700118	16	538	428	200	266	165	101	152	220	159	220	167	103	225	VB 190M	3004
8M01700218	16	538	428	200	266	165	101	152	220	159	220	167	103	225	VB 190M	3004
8M01700418	16	538	428	200	266	165	101	152	220	159	220	167	103	225	VB 190M	3004