

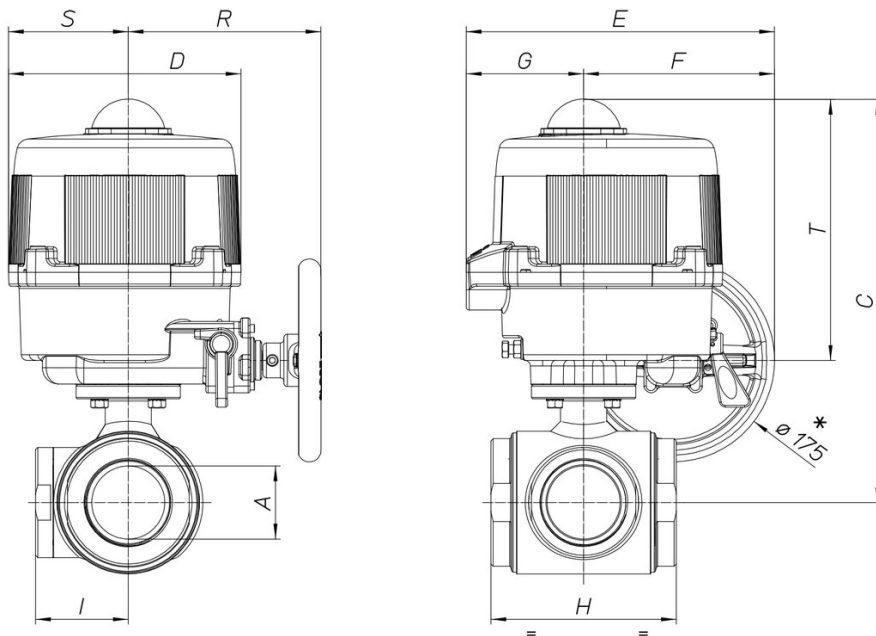

## 8M018

3 way polished ball valve, from ingot, 4 seals, stainless steel AISI 316, polished, ISO 228 F/F/F threaded, full bore, T or L port.

### Especificaciones técnicas



MOD	PN	C	D	E	F	G	H	I	R	S	T	ACT.
8M01800105	40	256	161	187	63	124	92	46	-	-	-	VB 030M*
8M01800205	40	256	161	187	63	124	92	46	-	-	-	VB 030M*
8M01800405	40	256	161	187	63	124	92	46	-	-	-	VB 030M*
8M01800106	40	260	161	187	63	124	102	51	-	-	-	VB 060M*
8M01800206	40	260	161	187	63	124	102	51	-	-	-	VB 060M*
8M01800406	40	260	161	187	63	124	102	51	-	-	-	VB 060M*
8M01800107	40	302	176	197	63	134	118	59	-	-	-	VB 060M
8M01800207	40	302	176	197	63	134	118	59	-	-	-	VB 060M
8M01800407	40	302	176	197	63	134	118	59	-	-	-	VB 060M
8M01800108	40	309	176	197	63	134	144	67	-	-	-	VB 060M*
8M01800208	40	309	176	197	63	134	144	67	-	-	-	VB 060M*
8M01800408	40	309	176	197	63	134	144	67	-	-	-	VB 060M*
8M01800110	25	312	176	197	63	134	144	72	-	-	-	VB 060M*
8M01800210	25	312	176	197	63	134	144	72	-	-	-	VB 060M*
8M01800410	25	312	176	197	63	134	144	72	-	-	-	VB 060M*
8M01800112	25	348	200	266	165	101	160	80	167	103	225	VB 110M
8M01800212	25	348	200	266	165	101	160	80	167	103	225	VB 110M
8M01800412	25	348	200	266	165	101	160	80	167	103	225	VB 110M
8M01800114	16	362	200	266	165	101	200	100	167	103	225	VB 190M
8M01800214	16	362	200	266	165	101	200	100	167	103	225	VB 190M
8M01800414	16	362	200	266	165	101	200	100	167	103	225	VB 190M
8M01800118	16	378	212	279	184	95	240	120	166	109	226	VB 300M
8M01800218	16	378	212	279	184	95	240	120	166	109	226	VB 300M
8M01800418	16	378	212	279	184	95	240	120	166	109	226	VB 300M