

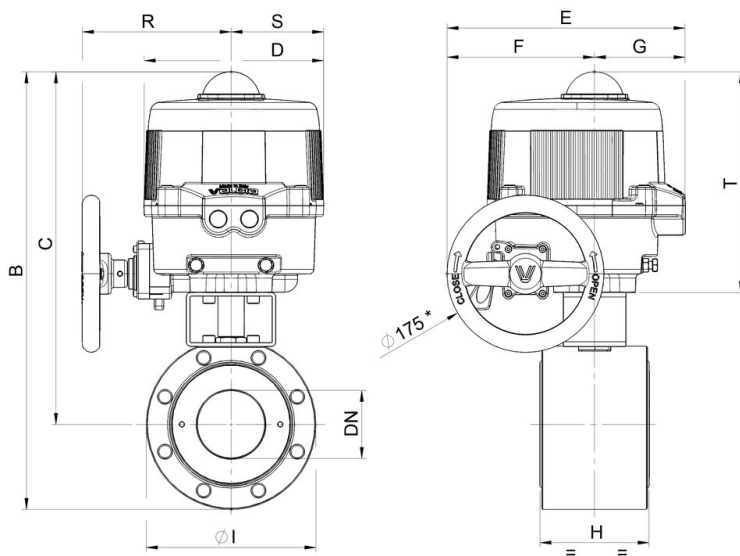

8M262

2 way Wafer ball valve [Valpres art.722V00 DN15 to DN100 (DN65 and DN100 only PN16) art.722V08 DN65 and DN100 only PN40] flanged PN16/40, carbon steel A105, full bore, EN 558 basic series 100, metric thread, V-Pack stem seal, Fire Safe, Antistatic Device. With electric actuator series 86.

Especificaciones técnicas



* mod.VB030M-VB060M Q10mm SENZA VOLANTINO - without handwheel

MOD	PN	B	C	D	E	F	G	H	ØI	R	S	ACT.	KIT
8M26200106	16-40	377	322	161	187	63	124	44	110	-	-	VB 030M	RI3542
8M26200206	16-40	377	322	161	187	63	124	44	110	-	-	VB 030M	RI3542
8M26200406	16-40	377	322	161	187	63	124	44	110	-	-	VB 030M	RI3542
8M26200107	16-40	411	346	176	197	63	134	52	130	-	-	VB 030M	RI3542
8M26200207	16-40	411	346	176	197	63	134	52	130	-	-	VB 030M	RI3542
8M26200407	16-40	411	346	176	197	63	134	52	130	-	-	VB 030M	RI3542
8M26200108	16-40	443	373	176	197	63	134	64	140	-	-	VB 060M	RI3521
8M26200208	16-40	443	373	176	197	63	134	64	140	-	-	VB 060M	RI3521
8M26200408	16-40	443	373	176	197	63	134	64	140	-	-	VB 060M	RI3521
8M26200110	16-40	457	382	176	197	63	134	83	150	-	-	VB 060M	RI3521
8M26200210	16-40	457	382	176	197	63	134	83	150	-	-	VB 060M	RI3521
8M26200410	16-40	457	382	176	197	63	134	83	150	-	-	VB 060M	RI3521
8M26200112	16	517	427	191	266	165	101	105	180	167	185	VB 110M	RI3522
8M26200212	16	517	427	191	266	165	101	105	180	167	185	VB 110M	RI3522
8M26200412	16	517	427	191	266	165	101	105	180	167	185	VB 110M	RI3522
8M26200114	40	517	427	191	266	165	101	105	180	167	185	VB 110M	RI5345
8M26200214	40	517	427	191	266	165	101	105	180	167	185	VB 110M	RI5345
8M26200414	40	517	427	191	266	165	101	105	180	167	185	VB 110M	RI5345
8M26200118	16-40	533	438	191	266	165	101	121	190	167	185	VB 190M	RI3552
8M26200218	16-40	533	438	191	266	165	101	121	190	167	185	VB 190M	RI3552
8M26200418	16-40	533	438	191	266	165	101	121	190	167	185	VB 190M	RI3552