

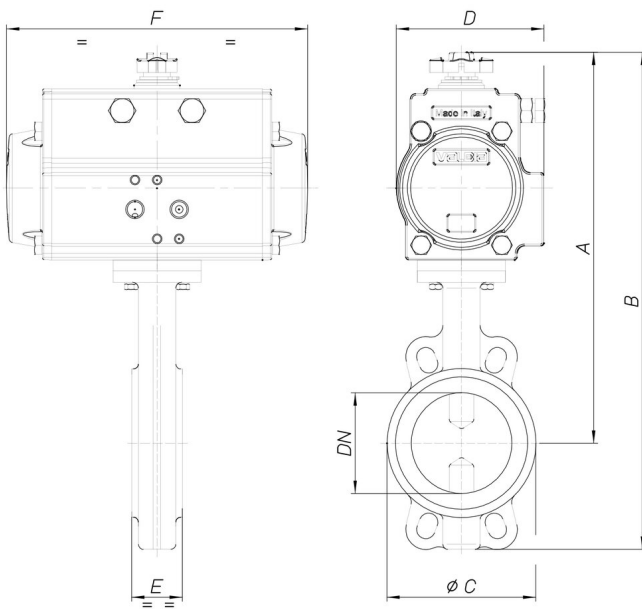

## 8P009700

Butterfly valve Wafer type PN16 (from DN50 to DN300), PN10 (from DN350 to DN600), body in cast iron GG25+ epoxy painting, disc GGG40 nickeled, EPDM [Valpres art. 600104] or NBR [Valpres art. 600117] seat from DN50 to DN300, EPDM seat art. 905276 from DN350 to DN600.

### Spécifications techniques



<b>MOD</b>	<b>PN</b>	<b>A</b>	<b>B</b>	<b>Ø C</b>	<b>D</b>	<b>E</b>	<b>F</b>	<b>ACT.</b>	<b>RI</b>
8P00970010	16	255	326	100	71	43	141	DA 52	3836
8P00970012	16	267	345	120	71	46	141	DA 52	3836
8P00970014	16	281	370	127	81	46	164	DA 63	3838
8P00970018	16	315	417	161	95	52	210	DA 75	3839
8P00970019	16	340	463	190	106	56	241	DA 85	3840
8P00970020	16	355	493	215	106	56	241	DA 85	3841
8P00970021	16	434	602	268	137	60	333	DA 115	3965
8P00970077	16	482	689	325	148	68	372	DA 125	3865
8P00970078	16	541	784	375	164	78	435	DA 140	3868