



8P109800

2 way Wafer ball valve [Valpres art. 721V00 DN15 to DN100 (DN65 and DN100 only PN16) art.721V78 DN65 and DN100 only PN40] flanged PN16/40, stainless steel A351-CF8M, full bore, EN 558 basic series 100, metric thread, V-Pack stem seal, Fire Safe, Antistatic Device.

NEW

Spécifications techniques

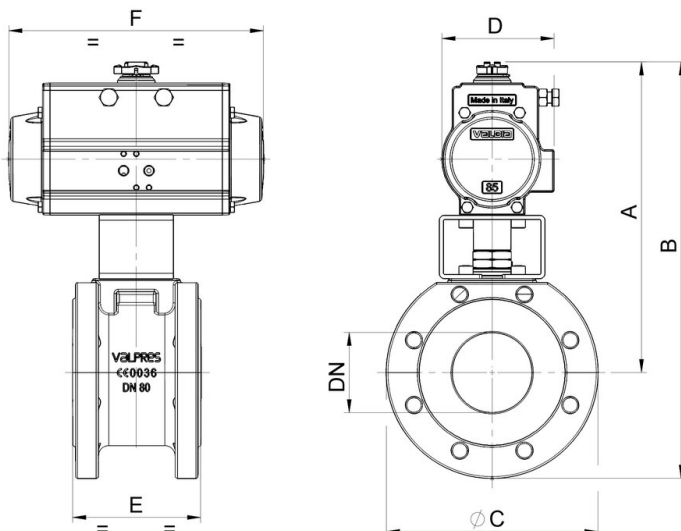

MOD	PN	A	B	ØC	D	E	F	ACT.	RI
8P10980004	16-40	149	197	95	45	36	110	DA 32	5343
8P10980005	16-40	190	243	105	71	39	141	DA 52	5344
8P10980006	16-40	198	256	115	71	44	141	DA 52	3542
8P10980007	16-40	202	272	140	71	52	141	DA 52	3521
8P10980008	16-40	235	310	150	81	64	164	DA 63	3521
8P10980010	16-40	261	344	165	95	83	210	DA 75	3526
8P10980012	16	288	380	185	106	105	241	DA 85	3522
8P10980014	40	288	380	185	106	105	241	DA 85	5345
8P10980018	16-40	294	394	200	106	121	241	DA 100	3522