

8E260

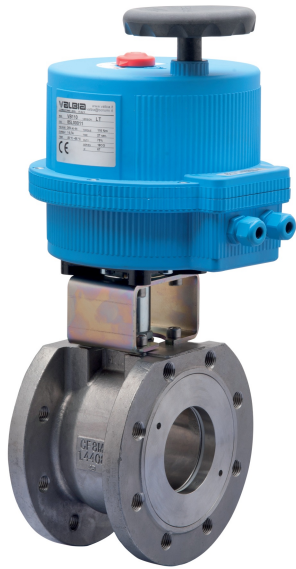

2 way Wafer ball valve [Valpres art. 721V00 DN15 to DN100 (DN65 and DN100 only PN16) art.721V78 DN65 and DN100 only PN40] flanged PN16/40, stainless steel A351-CF8M, full bore, EN 558 basic series 100, metric thread, V-Pack stem seal, Fire Safe, Antistatic Device. With electric actuator series 85.

NEW

Spécifications techniques

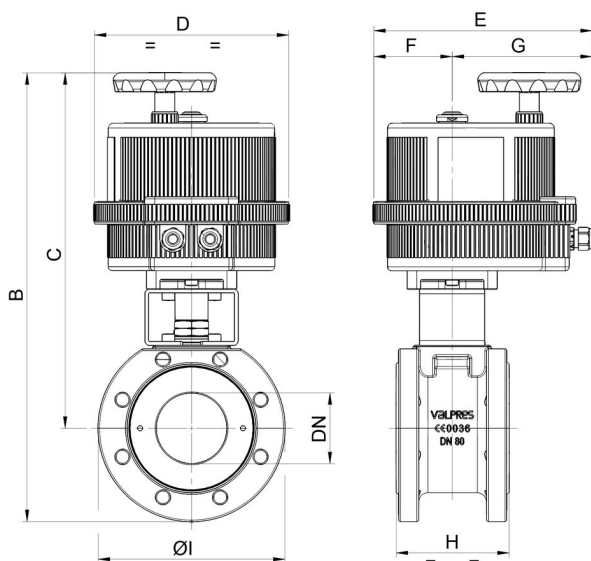

MOD	PN	B	C	D	E	F	G	H	I	ACT.	RI
8E26000104	16-40	269	224	123	164	43	121	35	90	VB 015	5344
8E26000204	16-40	269	224	123	164	43	121	35	90	VB 015	5344
8E26000404	16-40	269	224	123	164	43	121	35	90	VB 015	5344
8E26000105	16-40	278	228	123	164	43	121	40	100	VB 015	5344
8E26000205	16-40	278	228	123	164	43	121	40	100	VB 015	5344
8E26000405	16-40	278	228	123	164	43	121	40	100	VB 015	5344
8E26000106	16-40	340	282	157	191	61	130	46	115	VB 030	3542
8E26000206	16-40	340	282	157	191	61	130	46	115	VB 030	3542
8E26000406	16-40	340	282	157	191	61	130	46	115	VB 030	3542
8E26000107	16-40	358	288	157	191	61	130	54	140	VB 060	3542
8E26000207	16-40	358	288	157	191	61	130	54	140	VB 060	3542
8E26000407	16-40	358	288	157	191	61	130	54	140	VB 060	3542
8E26000108	16-40	404	329	185	215	68	147	64	150	VB 060	3521
8E26000208	16-40	404	329	185	215	68	147	64	150	VB 060	3521
8E26000408	16-40	404	329	185	215	68	147	64	150	VB 060	3521
8E26000110	16-40	420	337	185	215	68	147	82	165	VB 060	3521
8E26000210	16-40	420	337	185	215	68	147	82	165	VB 060	3521
8E26000410	16-40	420	337	185	215	68	147	82	165	VB 060	3521
8E26000112	16	465	372	211	237	84	153	103	185	VB 110	3522
8E26000212	16	465	372	211	237	84	153	103	185	VB 110	3522
8E26000412	16	465	372	211	237	84	153	103	185	VB 110	3522
8E26000114	40	465	372	211	237	84	153	103	185	VB 110	5345
8E26000214	40	465	372	211	237	84	153	103	185	VB 110	5345
8E26000414	40	465	372	211	237	84	153	103	185	VB 110	5345
8E26000118	16-40	479	379	211	237	84	153	122	200	VB 190	3552
8E26000218	16-40	479	379	211	237	84	153	122	200	VB 190	3552
8E26000418	16-40	479	379	211	237	84	153	122	200	VB 190	3552