

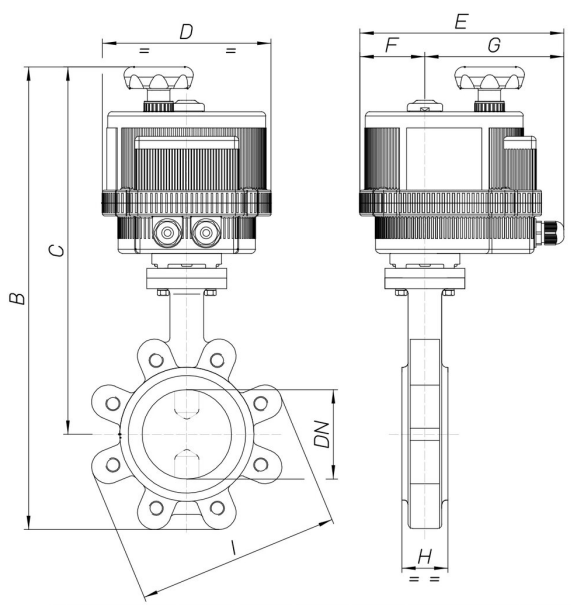

8E103

Butterfly valve Lug type PN16 (from DN50 to DN300), PN10 (from DN350 to DN600), body in cast iron GGG40 +epoxy painting, disc GGG40 nickered, EPDM [Valpres art. 600204] or NBR [Valpres art. 600231] from DN50 to DN300 EPDM seat art. 905277 from DN350 to DN600, with electric actuator series 85.

Spécifications techniques



MOD	PN	B	C	D	E	F	G	H	I	ACT.	RI
8E10300110	16	413	341	157	191	61	130	43	165	VB 030	3836
8E10300210	16	413	341	157	191	61	130	43	165	VB 030	3836
8E10300410	16	413	341	157	191	61	130	43	165	VB 030	3836
8E10300112	16	432	354	157	191	61	130	46	185	VB 030	3836
8E10300212	16	432	354	157	191	61	130	46	185	VB 030	3836
8E10300412	16	432	354	157	191	61	130	46	185	VB 030	3836
8E10300114	16	472	382	185	215	68	147	46	200	VB 060	3883
8E10300214	16	472	382	185	215	68	147	46	200	VB 060	3883
8E10300414	16	472	382	185	215	68	147	46	200	VB 060	3883
8E10300118	16	500	398	185	215	68	147	52	220	VB 060	3884
8E10300218	16	500	398	185	215	68	147	52	220	VB 060	3884
8E10300418	16	500	398	185	215	68	147	52	220	VB 060	3884
8E10300119	16	551	428	211	237	84	153	56	250	VB 110	3840
8E10300219	16	551	428	211	237	84	153	56	250	VB 110	3840
8E10300419	16	551	428	211	237	84	153	56	250	VB 110	3840
8E10300120	16	579	441	211	237	84	153	56	285	VB 190	3847
8E10300220	16	579	441	211	237	84	153	56	285	VB 190	3847
8E10300420	16	579	441	211	237	84	153	56	285	VB 190	3847
8E10300121	16	644	476	222	247	77	170	60	340	VB 270	3965
8E10300221	16	644	476	222	247	77	170	60	340	VB 270	3965
8E10300421	16	644	476	222	247	77	170	60	340	VB 270	3965
8E10300177	16	719	512	222	247	77	170	68	405	VB 350	3865
8E10300277	16	719	512	222	247	77	170	68	405	VB 350	3865
8E10300477	16	719	512	222	247	77	170	68	405	VB 350	3865