

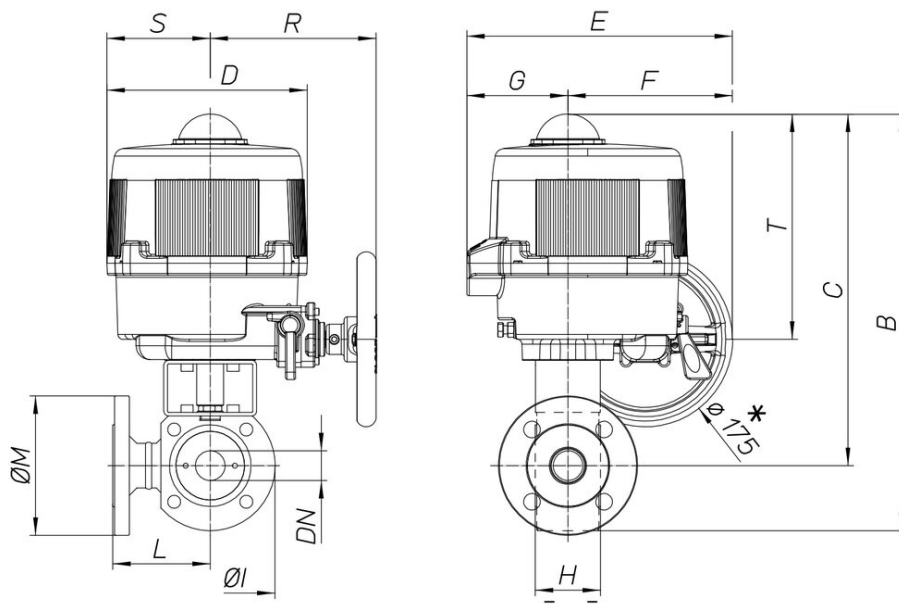

8M015

3 way Wafer ball valve diverting [Valpres art. 776001 (T) - 776000 (L)] T or L port, 2 seats, flanged PN16, carbon steel ASTM A105 reduced bore.

Spécifications techniques



MOD	PN	B	C	D	E	F	G	H	ØI	L	ØM	R	S	T	ACT.	RI
8M01500106	16	345	290	161	187	63	124	46	109	86	115	-	-	-	VB 030M	3001
8M01500206	16	345	290	161	187	63	124	46	109	86	115	-	-	-	VB 030M	3001
8M01500406	16	345	290	161	187	63	124	46	109	86	115	-	-	-	VB 030M	3001
8M01500107	16	363	298	161	187	63	124	58	130	105	140	-	-	-	VB 030M	3008
8M01500207	16	363	298	161	187	63	124	58	130	105	140	-	-	-	VB 030M	3008
8M01500407	16	363	298	161	187	63	124	58	130	105	140	-	-	-	VB 030M	3008
8M01500108	16	404	334	176	197	63	134	71	140	110	150	-	-	-	VB 060M	3002
8M01500208	16	404	334	176	197	63	134	71	140	110	150	-	-	-	VB 060M	3002
8M01500408	16	404	334	176	197	63	134	71	140	110	150	-	-	-	VB 060M	3002
8M01500110	16	420	340	176	197	63	134	82	160	115	165	-	-	-	VB 060M	3002
8M01500210	16	420	340	176	197	63	134	82	160	115	165	-	-	-	VB 060M	3002
8M01500410	16	420	340	176	197	63	134	82	160	115	165	-	-	-	VB 060M	3002
8M01500112	16	473	383	200	266	165	101	106	180	125	185	167	103	225	VB 110M	3003
8M01500212	16	473	383	200	266	165	101	106	180	125	185	167	103	225	VB 110M	3003
8M01500412	16	473	383	200	266	165	101	106	180	125	185	167	103	225	VB 110M	3003
8M01500114	16	491	391	200	266	165	101	122	200	150	200	167	103	225	VB 110M	3003
8M01500214	16	491	391	200	266	165	101	122	200	150	200	167	103	225	VB 110M	3003
8M01500414	16	491	391	200	266	165	101	122	200	150	200	167	103	225	VB 110M	3003
8M01500118	16	538	428	200	266	165	101	152	220	159	220	167	103	225	VB 190M	3004
8M01500218	16	538	428	200	266	165	101	152	220	159	220	167	103	225	VB 190M	3004
8M01500418	16	538	428	200	266	165	101	152	220	159	220	167	103	225	VB 190M	3004
8M01500119	16	578	454	200	266	165	101	196	250	190	250	167	103	225	VB 190M	4558
8M01500219	16	578	454	200	266	165	101	196	250	190	250	167	103	225	VB 190M	4558
8M01500419	16	578	454	200	266	165	101	196	250	190	250	167	103	225	VB 190M	4558
8M01500120	16	630	454	212	279	184	95	242	306	210	285	166	109	226	VB 350M	3042
8M01500220	16	630	454	212	279	184	95	242	306	210	285	166	109	226	VB 350M	3042
8M01500420	16	630	454	212	279	184	95	242	306	210	285	166	109	226	VB 350M	3042