

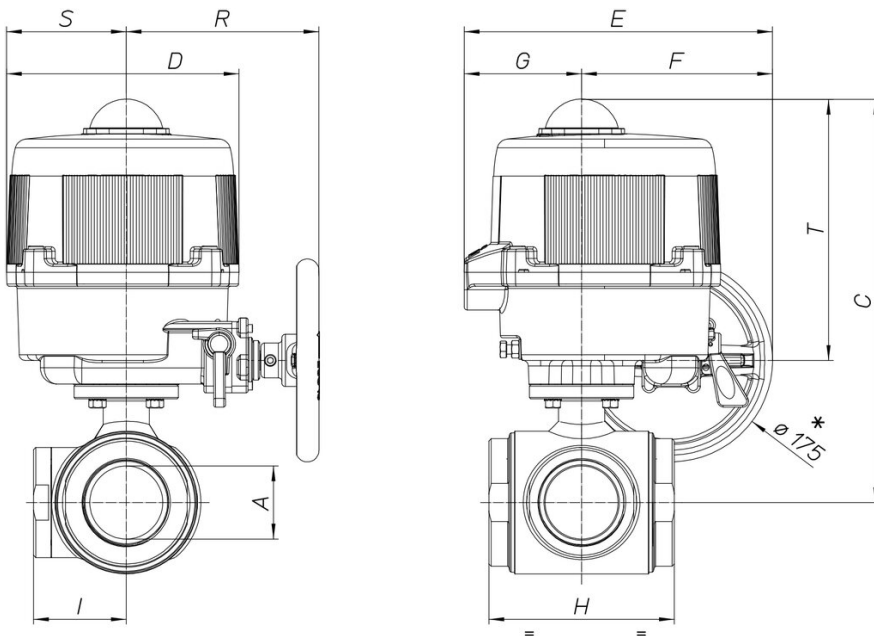

8M019

3 way polished ball valve, from ingot, 4 seals, stainless steel AISI 316, polished, ISO 228 F/F/F threaded, full bore, T or L port.

Spécifications techniques



MOD	PN	C	D	E	F	G	H	I	R	S	T	ACT.
8M01900105	40	256	161	187	63	124	92	46	-	-	-	VB 030M*
8M01900205	40	256	161	187	63	124	92	46	-	-	-	VB 030M*
8M01900405	40	256	161	187	63	124	92	46	-	-	-	VB 030M*
8M01900106	40	260	161	187	63	124	102	51	-	-	-	VB 060M*
8M01900206	40	260	161	187	63	124	102	51	-	-	-	VB 060M*
8M01900406	40	260	161	187	63	124	102	51	-	-	-	VB 060M*
8M01900107	40	302	176	197	63	134	118	59	-	-	-	VB 060M
8M01900207	40	302	176	197	63	134	118	59	-	-	-	VB 060M
8M01900407	40	302	176	197	63	134	118	59	-	-	-	VB 060M
8M01900108	40	309	176	197	63	134	144	67	-	-	-	VB 060M*
8M01900208	40	309	176	197	63	134	144	67	-	-	-	VB 060M*
8M01900408	40	309	176	197	63	134	144	67	-	-	-	VB 060M*
8M01900110	25	312	176	197	63	134	144	72	-	-	-	VB 060M*
8M01900210	25	312	176	197	63	134	144	72	-	-	-	VB 060M*
8M01900410	25	312	176	197	63	134	144	72	-	-	-	VB 060M*
8M01900112	25	348	200	266	165	101	160	80	167	103	225	VB 110M
8M01900212	25	348	200	266	165	101	160	80	167	103	225	VB 110M
8M01900412	25	348	200	266	165	101	160	80	167	103	225	VB 110M
8M01900114	16	362	200	266	165	101	200	100	167	103	225	VB 190M
8M01900214	16	362	200	266	165	101	200	100	167	103	225	VB 190M
8M01900414	16	362	200	266	165	101	200	100	167	103	225	VB 190M
8M01900118	16	378	212	279	184	95	240	120	166	109	226	VB 300M
8M01900218	16	378	212	279	184	95	240	120	166	109	226	VB 300M
8M01900418	16	378	212	279	184	95	240	120	166	109	226	VB 300M