

8M023

3 way flanged polished ball valve, from ingot, 4 seals, stainless steel AISI 316, full bore, T or L port.

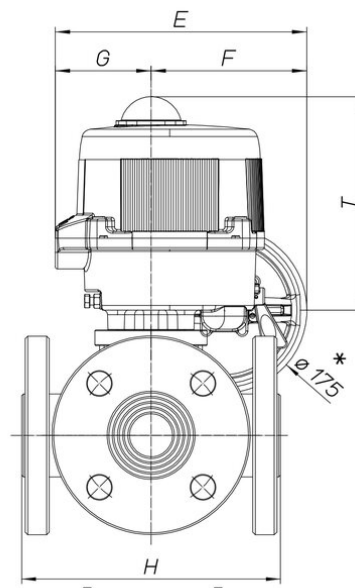

Spécifications techniques

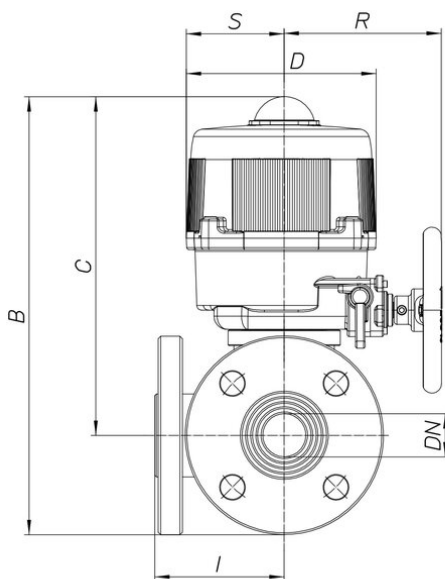

MOD	PN	B	C	D	E	F	G	H	I	R	S	T	ACT.
8M02300105	40	309	256	161	187	63	124	140	70	-	-	-	VB 030M*
8M02300205	40	309	256	161	187	63	124	140	70	-	-	-	VB 030M*
8M02300405	40	309	256	161	187	63	124	140	70	-	-	-	VB 030M*
8M02300106	40	318	260	161	187	63	124	150	75	-	-	-	VB 030M*
8M02300206	40	318	260	161	187	63	124	150	75	-	-	-	VB 030M*
8M02300406	40	318	260	161	187	63	124	150	75	-	-	-	VB 030M*
8M02300107	40	372	302	176	197	63	134	180	90	-	-	-	VB 060M
8M02300207	40	372	302	176	197	63	134	180	90	-	-	-	VB 060M
8M02300407	40	372	302	176	197	63	134	180	90	-	-	-	VB 060M
8M02300108	40	384	309	176	197	63	134	200	100	-	-	-	VB 060M
8M02300208	40	384	309	176	197	63	134	200	100	-	-	-	VB 060M
8M02300408	40	384	309	176	197	63	134	200	100	-	-	-	VB 060M
8M02300110	25	395	312	176	197	63	134	220	110	-	-	-	VB 060M*
8M02300210	25	395	312	176	197	63	134	220	110	-	-	-	VB 060M*
8M02300410	25	395	312	176	197	63	134	220	110	-	-	-	VB 060M*
8M02300112	16	441	348	200	266	165	101	240	120	167	103	225	VB 110M
8M02300212	16	441	348	200	266	165	101	240	120	167	103	225	VB 110M
8M02300412	16	441	348	200	266	165	101	240	120	167	103	225	VB 110M
8M02300114	16	462	362	00	266	165	101	260	130	167	103	225	VB 190M
8M02300214	16	462	362	00	266	165	101	260	130	167	103	225	VB 190M
8M02300414	16	462	362	00	266	165	101	260	130	167	103	225	VB 190M
8M02300118	16	488	378	212	279	184	95	300	150	166	109	226	VB 350M
8M02300218	16	488	378	212	279	184	95	300	150	166	109	226	VB 350M
8M02300418	16	488	378	212	279	184	95	300	150	166	109	226	VB 350M