

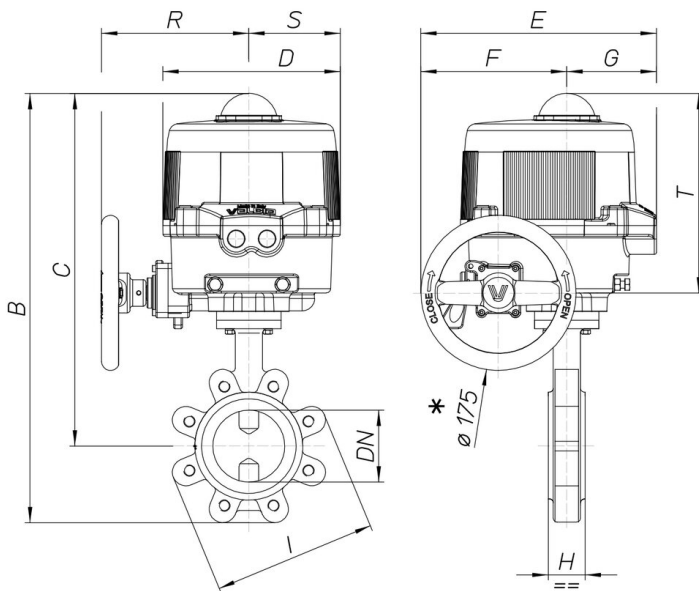

8M040

Butterfly valve Lug type PN16, (from DN40 to DN300)
PN10 (from DN350 to DN600) body in cast iron
GGG40+epoxy painting, disc AISI 316, EPDM [Valpres
art. 600205] or NBR [Valpres art. 600230] seat from
DN40 to DN300, EPDM seat art. 905262 from DN350 to
DN600.

Spécifications techniques



MOD	PN	B	C	D	E	F	G	H	I	R	S	T	ACT.	KIT
8M04000110	16	424	352	161	187	63	124	43	165	-	-	-	VB030M	RI3836
8M04000210	16	424	352	161	187	63	124	43	165	-	-	-	VB030M	RI3836
8M04000410	16	424	352	161	187	63	124	43	165	-	-	-	VB030M	RI3836
8M04000112	16	443	365	161	187	63	124	46	185	-	-	-	VB030M	RI3836
8M04000212	16	443	365	161	187	63	124	46	185	-	-	-	VB030M	RI3836
8M04000412	16	443	365	161	187	63	124	46	185	-	-	-	VB030M	RI3836
8M04000114	16	477	387	176	197	63	134	46	200	-	-	-	VB060M	RI3883
8M04000214	16	477	387	176	197	63	134	46	200	-	-	-	VB060M	RI3883
8M04000414	16	477	387	176	197	63	134	46	200	-	-	-	VB060M	RI3883
8M04000118	16	505	403	176	197	63	134	52	220	-	-	-	VB060M	RI3884
8M04000218	16	505	403	176	197	63	134	52	220	-	-	-	VB060M	RI3884
8M04000418	16	505	403	176	197	63	134	52	220	-	-	-	VB060M	RI3884
8M04000119	16	565	442	200	266	165	101	56	250	167	103	225	VB110M	RI3840
8M04000219	16	565	442	200	266	165	101	56	250	167	103	225	VB110M	RI3840
8M04000419	16	565	442	200	266	165	101	56	250	167	103	225	VB110M	RI3840
8M04000120	16	593	455	200	266	165	101	56	285	167	103	225	VB190M	RI3847
8M04000220	16	593	455	200	266	165	101	56	285	167	103	225	VB190M	RI3847
8M04000420	16	593	455	200	266	165	101	56	285	167	103	225	VB190M	RI3847
8M04000121	16	658	490	212	279	184	95	60	340	166	109	226	VB270M	RI3965
8M04000221	16	658	490	212	279	184	95	60	340	166	109	226	VB270M	RI3965
8M04000421	16	658	490	212	279	184	95	60	340	166	109	226	VB270M	RI3965
8M04000177	16	733	526	212	279	184	95	68	405	166	109	226	VB350M	RI3865
8M04000277	16	733	526	212	279	184	95	68	405	166	109	226	VB350M	RI3865
8M04000477	16	733	526	212	279	184	95	68	405	166	109	226	VB350M	RI3865