

MOD. VB110

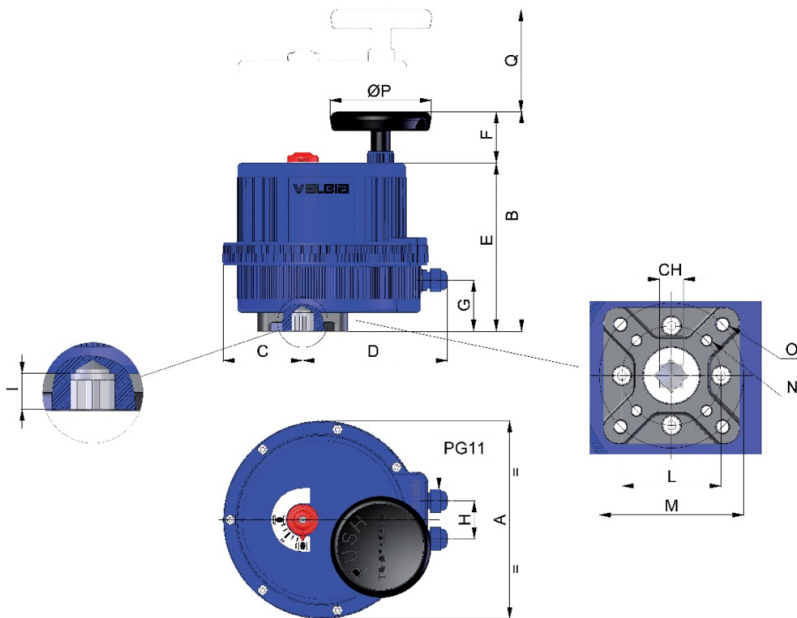

Specifiche tecniche



| MOD | FORATURA DRILLING ISO 5211 | CH | A | B | C | D | E | F | G | H | I | L | M | N | O | ØP | Q |
|------------|----------------------------|----|-----|-------|----|-----|-----|------|----|----|----|----|-----|-------|--------|-----|-----|
| MOD. VB110 | F07-F10 | 17 | 211 | 232,1 | 84 | 153 | 178 | 54,1 | 54 | 40 | 19 | 70 | 102 | M8X20 | M10X20 | 110 | 115 |

Applicazioni



FOOD &
BEVERAGE



HVAC



PAINTS &
SOLVENTS



WATER
TREATMENT



CHEMICAL



OEM



POWER &
RENEWABLE
ENERGY