

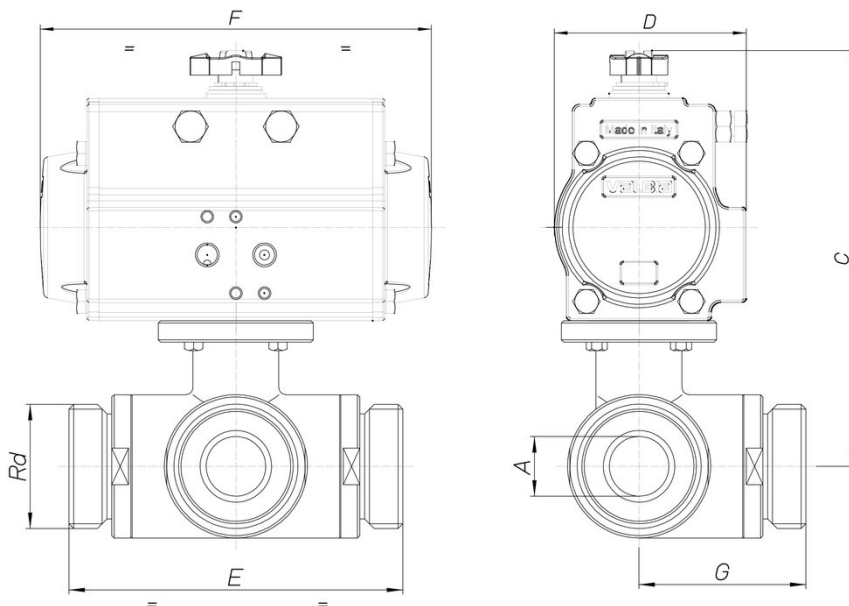

8P021900

Valvola a sfera ricavata da massello, 3 vie, 4 guarnizioni in PTFE vergine, lucida, acciaio inox AISI 316, attacchi DIN 11851 F/F/F, passaggio TOTALE, sfera forata a "T" o "L", con attuatore.

Specifiche tecniche



MOD	PN	A	RD	C	D	E	F	G	ACT.
8P02190003	40	10	28x1/8"	148	71	108	141	54	DA 52
8P02190004	40	15	34x1/8"	151	71	118	141	59	DA 52
8P02190005	40	20	44x1/6"	170	81	130	164	65	DA 63
8P02190006	40	25	52x1/6"	174	81	140	164	70	DA 63
8P02190007	40	32	58x1/6"	195	81	156	164	78	DA 63
8P02190008	40	40	65x1/6"	220	95	172	210	86	DA 75
8P02190010	25	50	78x1/6"	237	106	182	241	91	DA 85
8P02190012	25	65	95x1/6"	247	106	196	241	98	DA 85
8P02190014	16	80	110x1/4"	274	123	256	275	128	DA 100
8P02190018	16	100	130x1/4"	289	123	286	275	143	DA 100