

8P007600

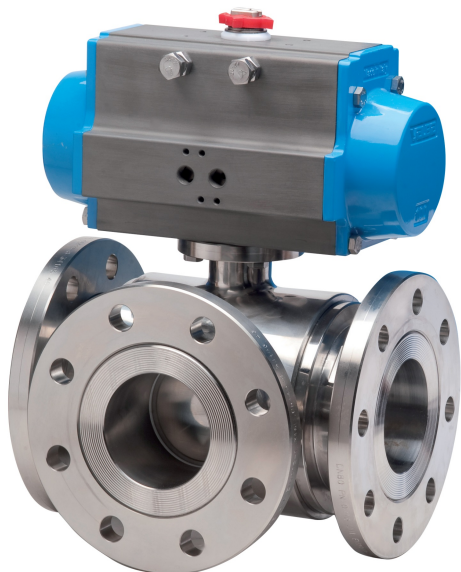

Valvola a sfera ricavata da massello, 3 vie, 4 guarnizioni, lucida, acciaio inox AISI 316, flangiata, a passaggio TOTALE, sfera forata a "T" o "L", con attuatore.

Specifiche tecniche

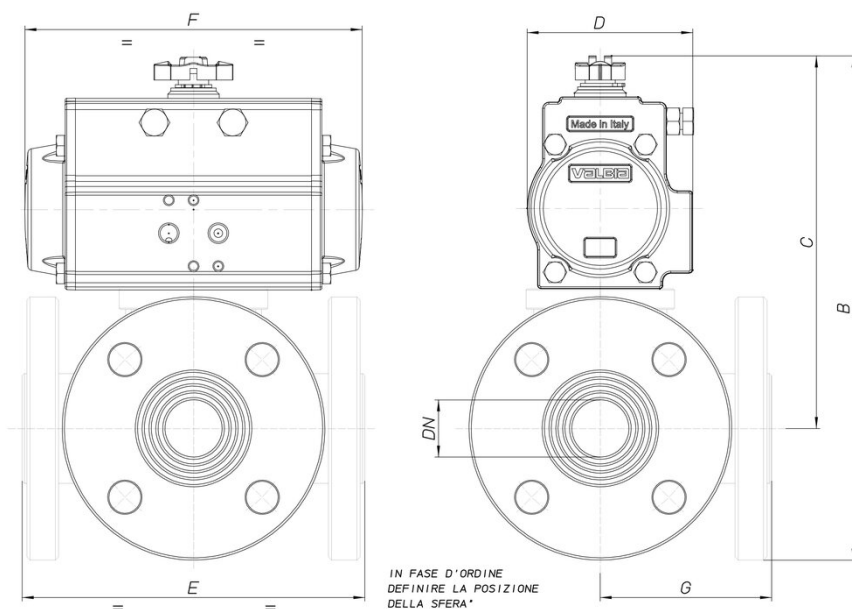

MOD	PN	B	C	D	E	F	G	ACT.
8P00760003	40	255	210	81	120	164	60	SR 63
8P00760004	40	260	212	81	130	164	65	SR 63
8P00760005	40	255	202	106	140	241	70	SR 85
8P00760006	40	264	206	106	150	241	75	SR 85
8P00760007	40	297	227	106	180	241	90	SR 85
8P00760008	40	322	247	123	200	275	100	SR 100
8P00760010	25	333	250	123	220	275	110	SR 100
8P00760012	16	387	294	137	240	333	120	SR 115
8P00760014	16	421	321	148	260	372	130	SR 125
8P00760018	16	468	358	164	300	435	150	SR 140